

OPENETICS

Guía de Producto Nº23



Soluciones VDI para redes
LAN empresariales de
última generación

SOMOS OPENETICS

Fabricamos sistemas de cableado estructurado de cobre y fibra óptica para redes de "última generación", con un rendimiento superior conforme a los estándares ANSI/TIA-568-C2 e ISO/IEC 11801.

"We build the present,
we plan the future
since 1998."

Avalan nuestro sistema de calidad



Los sistemas integrales de cableado estructurado de OPENETICS cumplen las normativas internacionales



Guía de colores de las Euroclases CPR (Construction Products Regulation)



Nivel de reacción al fuego



Menor prestación

Mayor prestación

SOLUCIONES DE VOZ Y DATOS PARA REDES LAN EMPRESARIALES



Sistemas de Cableado Estructurado de Cobre

Categoría 6 / 6A / 7 / 7A y 8

3



Sistemas de Cableado Estructurado de Fibra Óptica

Multimodo (OM1 / OM2 / OM3 / OM4) y monomodo (OS2)

19



ICT-2 Infraestructura Común de Telecomunicaciones

Planta interna, planta externa y equipos de medición ICT-2

41



Electrónica de Red

Switches Fast Ethernet, Gigabit, convertidores y módulos SFP

53



Armarios Rack 19"

Racks murales, de pie, para servidores, de intemperie, etc.

59

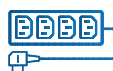

PDU Regletas Eléctricas Profesionales

PDU 19", PDU "cero U", "Datacenter Grade", TCP/IP y STS

75

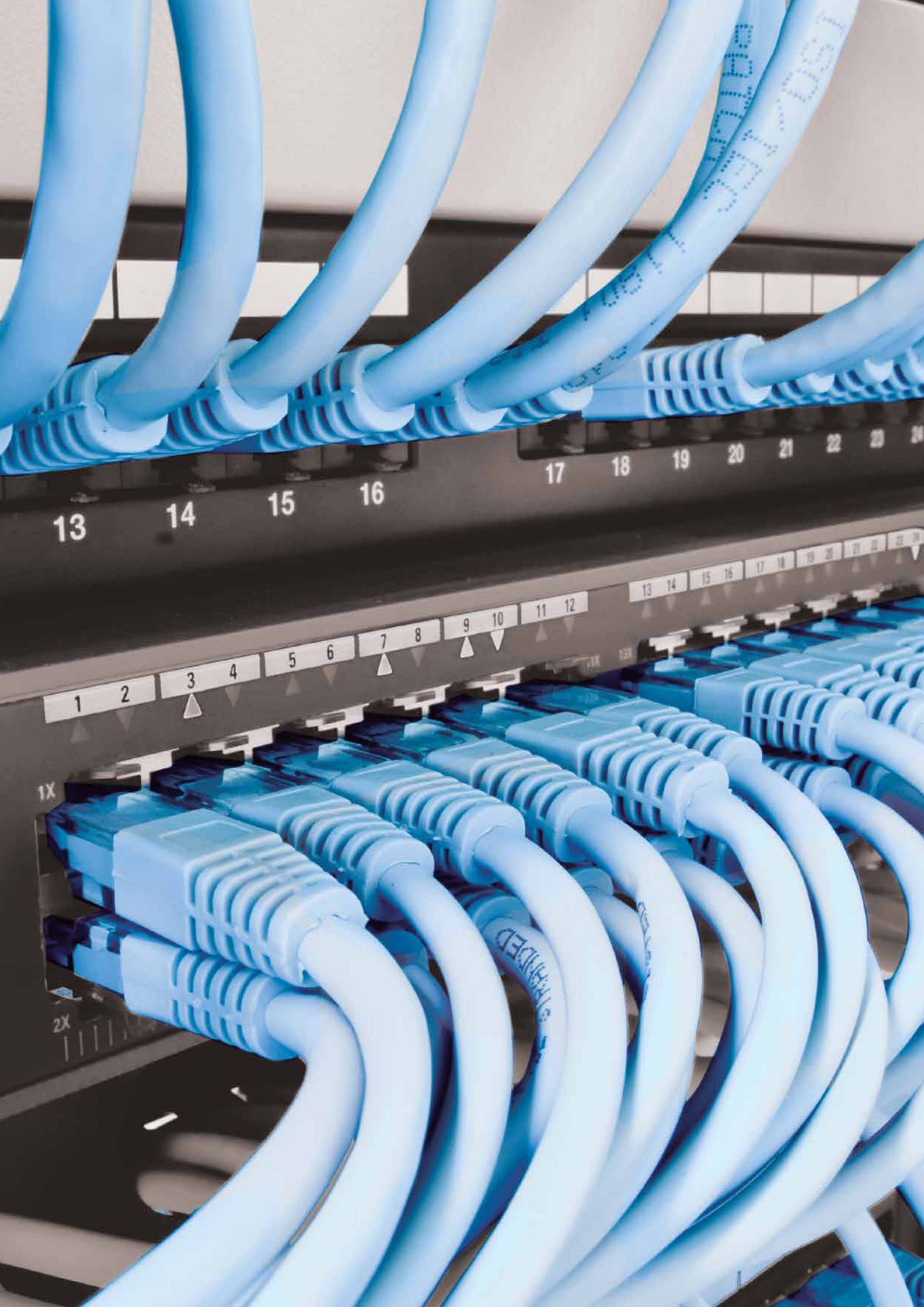



Sistemas de Cableado Estructurado de Cobre

Categoría 8	4
Categoría 7A	5
Categoría 7	5
Categoría 6A	6
Categoría 6	10
Herramientas de cableado estructurado de cobre y coaxial	14

CONECTIVIDAD EN PUESTOS DE TRABAJO

Cajas de empotrar en mesas de reuniones	16
Puntos de consolidación	16
Cajas de superficie, de empotrar y terminales de falso suelo	17

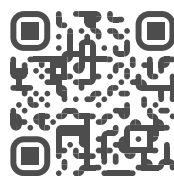

Configura tu proyecto de cableado estructurado en tres simples pasos con myNET

mynet.openetics.com





CABLES CAT. 8

Cable Cable Cat. 8 S/FTP	Ref.	U/Emb.
Cable Cat. 8 S/FTP rígido LSZH Dca s1, d2, a1 en bobinas de 500 m	0754	500
Cable Cat. 8 S/FTP LSZH flexible, color naranja, en bobinas 500 m	0244	500

LATIGUILLOS CAT. 8



Latiguillos Cat. 8 S/FTP	Ref.	U/Emb.
Latiguillo Cat. 8 S/FTP LSZH 1 m	67501	1
Latiguillo Cat. 8 S/FTP LSZH 2 m	67502	1
Latiguillo Cat. 8 S/FTP LSZH 3 m	67503	1
Latiguillo Cat. 8 S/FTP LSZH 5 m	67505	1
Latiguillo Cat. 8 S/FTP LSZH 10 m	67510	1

PANELES DE PARCHEO CAT. 8



Panel Vacío	Ref.	U/Emb.
Patch panel vacío 1 U 24 puertos UTP-FTP, modelo Slim	05619	1
¡Nuevo! Patch panel vacío 1 U 24 puertos UTP-STP modelo Slim, con etiquetero	05614	1
¡Nuevo! Patch panel vacío 2 U 48 puertos UTP-FTP, modelo Slim	05616	1

CONECTORES CAT. 8



Conectores Cat. 8 Hembra	Ref.	U/Emb.
Conector RJ45 Cat. 8 S/FTP hembra tool-less	5849	1



Conectores Cat. 8 Macho	Ref.	U/Emb.
Conector RJ45 Cat. 8 FTP macho para cable flexible	0026	100
Conector RJ45 Cat. 8 FTP macho para cable flexible/rígido tool-less	2233	1

Ref. 2251



Accesorio para Conectores RJ45 Hembra	Ref.	U/Emb.
Set de 10 tapones antipolvo para conector RJ45 hembra	22551	1

SISTEMA DE AUTOCIERRE



Sistema de Autocierre 13 y 20 mm	Ref.	U/Emb.
Sistema de autocierre 13 mm color negro	8400	1
Sistema de autocierre 20 mm color negro	8405	1

CPR

Ref. 0851C

**CABLES CAT. 7A****Cable Cat. 7A S/FTP**

Cable Cat. 7A S/FTP rígido LSZH Cca s1a,d1,a1
en bobinas de 500 m

Ref.

0851C

U/Emb.

500

CABLES CAT. 7**CPR**

Ref. 0829D2

**Cable Cat. 7 F/FTP**

Cable Cat. 7 F/FTP rígido LSZH Dca s2,d2,a1
en bobinas de 500 m

Ref.

0829D2

U/Emb.

500 m

SISTEMA DE AUTOCIERRE 13 MM Y 20 MM

Ref. 8405

**Sistema de Autocierre 13 mm**

Sistema de autocierre 13 mm color negro

Ref.

8400

U/Emb.

25 m

Sistema de Autocierre 20 mm

Sistema de autocierre 20 mm color negro

Ref.

8405

U/Emb.

25 m

CABLES CAT. 6A



Cable Cat. 6A U/UTP	Ref.	U/Emb.
¡Nuevo! Cable Cat. 6A U/UTP rígido LSZH B2ca s1a,d1,a1 en bobinas de 500 m	0850B	500m
Cable Cat. 6A U/UTP rígido LSZH Cca s1a,d1,a1 en bobinas de 500 m	0850C	500m



Cable Cat. 6A U/UTP rígido LSZH Dca s2,d2,a1 en bobinas de 500 m	0849D2	500 m
Cable Cat. 6A U/UTP flexible LSZH en bobinas de 500 m	0610	500 m



Cable Cat. 6A F/FTP y F/UTP	Ref.	U/Emb.
Cable Cat. 6A F/FTP rígido LSZH Cca s1a,d1,a1 en bobinas de 500 m	0848C	500 m
Cable Cat. 6A F/UTP rígido LSZH Dca s2,d2,a1 en bobinas de 500 m	0701D2	500 m



Cable Cat. 6A para Exterior	Ref.	U/Emb.
¡Nuevo! Cable Cat. 6A UTP rígido para exterior PE Fca en bobinas de 500 m	0266F2	500 m

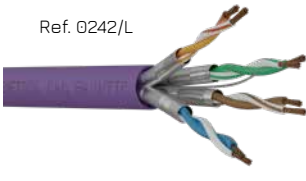

Cable Cat. 6A U/FTP LSZH Flexible	Ref.	U/Emb.
Cable Cat. 6A U/FTP LSZH flexible, color gris, en bobinas 500 m	0242	500 m
Cable Cat. 6A U/FTP LSZH flexible, color azul, en bobinas 500 m	0242/A	500 m
Cable Cat. 6A U/FTP LSZH flexible, color lila, en bobinas 500 m	0242/L	500 m
Cable Cat. 6A U/FTP LSZH flexible, color rojo, en bobinas 500 m	0242/R	500 m
Cable Cat. 6A U/FTP LSZH flexible, color verde, bobinas 500 m	0242/V	500 m
Cable Cat. 6A U/FTP LSZH flexible, color amarillo, en bobinas 500 m	0242/Y	500 m

LATIGUILLOS CAT. 6A

Ref. 67200



Latiguillos Cat. 6A U/UTP	Ref.	U/Emb.
Latiguillo Cat. 6A U/UTP LSZH 0,5 m	67200	1
Latiguillo Cat. 6A U/UTP LSZH 1 m	67201	1
Latiguillo Cat. 6A U/UTP LSZH 2 m	67202	1
Latiguillo Cat. 6A U/UTP LSZH 3 m	67203	1
Latiguillo Cat. 6A U/UTP LSZH 5 m	67205	1
Latiguillo Cat. 6A U/UTP LSZH 10 m	67210	1

Otras longitudes y colores, consultar.

Ref. 67303



Latiguillos Cat. 6A U/FTP	Ref.	U/Emb.
Latiguillo Cat. 6A U/FTP LSZH 0,5 m	67300	1
Latiguillo Cat. 6A U/FTP LSZH 1 m	67301	1
Latiguillo Cat. 6A U/FTP LSZH 2 m	67302	1
Latiguillo Cat. 6A U/FTP LSZH 3 m	67303	1
Latiguillo Cat. 6A U/FTP LSZH 5 m	67305	1
Latiguillo Cat. 6A U/FTP LSZH 10 m	67310	1

Otras longitudes y colores, consultar.

PANELES DE PARCHEO CAT. 6A

Ref. 05618



Panel Cat. 6A UTP GIGALAN 500+	Ref.	U/Emb.
Patch panel 1 U 24 puertos Cat 6A UTP, modelo Gigalan 500+	05618	1

Ref. 05619



Panel Vacío	Ref.	U/Emb.
Patch panel vacío 1 U 24 puertos UTP-FTP, modelo Slim	05619	1
Patch panel vacío 1 U 24 puertos vacío Cat. 6A FTP	5812	1

Ref. 05614



¡Nuevo! Patch panel vacío 1 U 24 puertos UTP-STP modelo Slim, con etiquetero	05614	1
¡Nuevo! Patch panel vacío 2 U 48 puertos UTP-FTP, modelo Slim	05616	1

Ref. 50036



PRODUCTOS MODULARES PARA CARRIL DIN

Módulos Cat. 6A para Carril DIN	Ref.	U/Emb.
Módulo Cat. 6A FTP RJ45 para carril DIN (conector incluido)	50036	1

Ref. 5844



CONECTORES CAT. 6A

Conectores Cat. 6A Hembra	Ref.	U/Emb.
Conector RJ45 Cat. 6A UTP hembra, modelo Mach3	5844	25
Conector RJ45 Cat. 6A UTP hembra 180°	5848	25
¡Nuevo! Conector RJ45 Cat. 6A UTP hembra 180° slim tool-less	5823	25
Conector RJ45 Cat. 6A FTP hembra tool-less	05834	25
Conector RJ45 Cat. 6A S/FTP hembra salida 270°	22550	1

Ref. 5848



Accesorio para Conectores RJ45 Hembra	Ref.	U/Emb.
Set de 10 tapones antipolvo para conector RJ45 hembra	22551	10

Ref. 22551



Ref. 0022



Conectores Cat. 6A Macho	Ref.	U/Emb.
Conector RJ45 Cat. 6A UTP macho para cable flexible	0023	100
Conector RJ45 Cat. 6A FTP macho para cable flexible	0022	100

Ref. 12211



Cubre Conector Cat.6A para Cable Rígido	Ref.	U/Emb.
Cubre conector RJ45 Cat. 6A para cable rígido	12211	100

Ref. 2221



CONECTORES ETHERNET INDUSTRIAL CAT. 6A

Conectores Ethernet Industrial Cat. 6A	Ref.	U/Emb.
Conector RJ45 ethernet industrial Cat. 6A UTP/STP macho para cable rígido y flexible AWG 24-26	2221	1
Conector RJ45 ethernet industrial Cat. 6A UTP/STP macho para cable rígido y flexible AWG 22-26 (tool-less)	2222	1
Conector RJ45 ethernet industrial Cat. 6A UTP/STP macho para cable rígido y flexible AWG 23-26 (tool-less)	2232	1

Ref. 2222



Ref. 2232



Herramienta para Crimpar Conectores Industriales RJ45 de la Ref. 2221	Ref.	U/Emb.
Herramienta para crimpar RJ45 industrial	2250	1

Ref. 2250



Ref. 50029



MÓDULOS PARA DATOS

Módulos Cat. 6A	Ref.	U/Emb.
Adaptador Cat. 6A UTP doble hembra RJ45-RJ45	50026	1
Adaptador Cat. 6A FTP doble hembra RJ49-RJ49	50029	1

Ref. 22190



SOLUCIÓN MACH3

Solución Mach3	Ref.	U/Emb.
Conector RJ45 Cat. 6A UTP hembra, modelo Mach3	5844	25
Herramienta de conexión y corte rápido RJ45, modelo Mach3	22190	1

SISTEMA DE AUTOCIERRE 13 MM Y 20 MM

Ref. 8405



Sistema de Autocierre 13 mm	Ref.	U/Emb.
Sistema de autocierre 13 mm color negro	8400	25 m
Sistema de Autocierre 20 mm	Ref.	U/Emb.
Sistema de autocierre 20 mm color negro	8405	25 m



CABLES CAT. 6

Cable Cat. 6 U/UTP sin Cruceta Separadora	Ref.	U/Emb.
Cable Cat. 6 U/UTP flexible LSZH en bobinas de 500 m	0609	500 m

Cable Cat. 6 U/UTP con Cruceta Separadora	Ref.	U/Emb.
Cable Cat. 6 U/UTP rígido LSZH Cca s1,d1,a1 en bobinas de 500 m	0702C	500 m
Cable Cat. 6 U/UTP rígido LSZH Dca s2,d2,a1 en cajas de 305 m	0706D2	305 m
Cable Cat. 6 U/UTP rígido LSZH Dca s2,d2,a1 en bobinas de 500 m	0702D2	500 m
Cable Cat. 6 U/UTP rígido LSZH Dca s2,d2,a1 en bobinas de 1.000 m	0703D2	1000 m



Cable Cat. 6 F/UTP	Ref.	U/Emb.
Cable Cat. 6 F/UTP rígido LSZH Dca s2,d2,a1 en bobinas de 500 m	0809D2	500 m



Cable Cat. 6 para Exterior	Ref.	U/Emb.
Cable Cat. 6 U/UTP antirroedor para exterior Fca en bobinas de 1000 m	0755	1000 m
Cable Cat. 6 U/UTP rígido para exterior PE Fca en bobinas de 500 m	0166F2	500 m
Cable Cat. 6 F/UTP rígido para exterior PE Fca en bobinas de 500 m	0167F2	500 m

LATIGUILLOS PLANOS CAT. 6

Latiguillos Planos Cat. 6 U/UTP, modelo FLAT Patch	Ref.	U/Emb.
Latiguillo plano Cat. 6 U/UTP 0,25 m	67399	1
Latiguillo plano Cat. 6 U/UTP 0,5 m	67400	1
Latiguillo plano Cat. 6 U/UTP 1 m	67401	1
Latiguillo plano Cat. 6 U/UTP 2 m	67402	1
Latiguillo plano Cat. 6 U/UTP 3 m	67403	1
Latiguillo plano Cat. 6 U/UTP 5 m	67405	1
Latiguillo plano Cat. 6 U/UTP 10 m	67410	1



LATIGUILLOS CAT. 6

Ref. 6700



Latiguillos Cat. 6 U/UTP LSZH	Ref.	U/Emb.
Latiguillo Cat. 6 U/UTP LSZH 0,5 m	6700	1
Latiguillo Cat. 6 U/UTP LSZH 1 m	6701	1
Latiguillo Cat. 6 U/UTP LSZH 2 m	6822	1
Latiguillo Cat. 6 U/UTP LSZH 3 m	6823	1
Latiguillo Cat. 6 U/UTP LSZH 5 m	6825	1
Latiguillo Cat. 6 U/UTP LSZH 10 m	6830	1

Otras longitudes y colores, consultar.

Ref. 6799A



Latiguillos Cat. 6 U/UTP de Colores	Ref.	Ref.	U/Emb.
	LSZH	PVC	
■ Latiguillo Cat. 6 U/UTP 0,5 m azul	6700A	6799A	1
■ Latiguillo Cat. 6 U/UTP 1 m azul	6701A	6801A	1
■ Latiguillo Cat. 6 U/UTP 2 m azul	6822A	6802A	1
■ Latiguillo Cat. 6 U/UTP 3 m azul	6823A	6803A	1
■ Latiguillo Cat. 6 U/UTP 5 m azul	6825A	6805A	1

Ref. 6799R



■ Latiguillo Cat. 6 U/UTP 0,5 m rojo	6700R	6799R	1
■ Latiguillo Cat. 6 U/UTP 1 m rojo	6701R	6801R	1
■ Latiguillo Cat. 6 U/UTP 2 m rojo	6822R	6802R	1
■ Latiguillo Cat. 6 U/UTP 3 m rojo	6823R	6803R	1
■ Latiguillo Cat. 6 U/UTP 5 m rojo	6825R	6805R	1

Ref. 6799V



■ Latiguillo Cat. 6 U/UTP 0,5 m verde	6700V	6799V	1
■ Latiguillo Cat. 6 U/UTP 1 m verde	6701V	6801V	1
■ Latiguillo Cat. 6 U/UTP 2 m verde	6822V	6802V	1
■ Latiguillo Cat. 6 U/UTP 3 m verde	6823V	6803V	1
■ Latiguillo Cat. 6 U/UTP 5 m verde	6825V	6805V	1

Ref. 6799Y



■ Latiguillo Cat. 6 U/UTP 0,5 m amarillo	6700Y	6799Y	1
■ Latiguillo Cat. 6 U/UTP 1 m amarillo	6701Y	6801Y	1
■ Latiguillo Cat. 6 U/UTP 2 m amarillo	6822Y	6802Y	1
■ Latiguillo Cat. 6 U/UTP 3 m amarillo	6823Y	6803Y	1
■ Latiguillo Cat. 6 U/UTP 5 m amarillo	6825Y	6805Y	1

Otras longitudes, consultar.

Ref. 6853



Latiguillos Cat. 6 F/UTP LSZH	Ref.	U/Emb.
Latiguillo Cat. 6 F/UTP LSZH 0,5 m	6850	1
Latiguillo Cat. 6 F/UTP LSZH 1 m	6851	1
Latiguillo Cat. 6 F/UTP LSZH 2 m	6852	1
Latiguillo Cat. 6 F/UTP LSZH 3 m	6853	1
Latiguillo Cat. 6 F/UTP LSZH 5 m	6855	1
Latiguillo Cat. 6 F/UTP LSZH 10 m	6860	1

Ref. 05617



Ref. 5810



Ref. 5516



Ref. 05614



Ref. 50076



Ref. 5843



Ref. 22551



Ref. 0020

Ref. 1209



PANELES DE PARCHEO CAT. 6

Paneles Cat. 6 UTP GIGALAN 350+	Ref.	U/Emb.
Patch panel 1U 24 puertos Cat. 6 UTP, modelo Gigalan 350	05617	1
Patch panel 12 puertos Cat. 6 UTP	5615	1
Panel FTP	Ref.	U/Emb.
Patch panel 1 U 24 puertos Cat. 6 FTP	5810	1
Paneles Vacíos	Ref.	U/Emb.
Patch panel vacío 1 U 16 puertos	5515	1
Patch panel vacío 2 U 32 puertos	5516	1
Patch panel vacío 1 U 24 puertos UTP-FTP, modelo Slim	05619	1
¡Nuevo! Patch panel vacío 1 U 24 puertos UTP-STP modelo Slim, con etiquetero	05614	1
¡Nuevo! Patch panel vacío 2 U 48 puertos UTP-FTP, modelo Slim	05616	1

PRODUCTOS MODULARES PARA CARRIL DIN

Módulos Cat. 6 para Carril DIN	Ref.	U/Emb.
Módulo Cat. 6 UTP RJ45 para carril DIN (conector incluido)	50043	1
Módulo Cat. 6 FTP RJ49 para carril DIN (conector incluido)	50076	1

CONECTORES CAT. 6

Conectores Cat. 6 Hembra	Ref.	U/Emb.
Conector RJ45 Cat 6 UTP hembra 180°	5847	25
Conector RJ45 Cat.6 UTP hembra tool-less	5822	25
Conector RJ45 Cat. 6 UTP hembra, modelo Mach3	5843	25
Conector RJ45 Cat. 6 FTP hembra tool-less	05845	25

Accesorio para Conectores RJ45 Hembra	Ref.	U/Emb.
Set de 10 tapones antipolvo para conector RJ45 hembra	22551	10

Conectores Cat. 6 Macho	Ref.	U/Emb.
Conector RJ45 Cat. 6 UTP macho para cable flexible	0020	100
Conector RJ45 Cat. 6 FTP macho para cable flexible	1209	100

Cubre Conectores Cat. 6	Ref.	U/Emb.
■ Cubre conector RJ45 Cat. 6 gris	1210	100
■ Cubre conector RJ45 Cat. 6 rojo	1224	100
■ Cubre conector RJ45 Cat. 6 azul	1225	100
■ Cubre conector RJ45 Cat. 6 verde	1226	100
■ Cubre conector RJ45 Cat. 6 amarillo	1227	100
■ Cubre conector RJ45 Cat. 6 negro	1229	100

Ref. 05604



Ref. 05606



ROSETAS CAT. 6

Rosetas Cat. 6 UTP	Ref.	U/Emb.
Roseta Cat. 6 con 1 conector UTP RJ45 con persiana	05604	1
Roseta Cat. 6 con 2 conectores UTP RJ45 con persiana	05606	1

Ref. 50025



MÓDULOS PARA DATOS

Módulos Cat. 6	Ref.	U/Emb.
Adaptador Cat. 6 UTP doble hembra RJ45-RJ45	50025	1
Adaptador Cat. 6 FTP doble hembra RJ49-RJ49	50028	1

Ref. 4692



EMPALMADOR CAT. 6

Empalmador para Cable Cat. 6 UTP	Ref.	U/Emb.
Empalmador para cable Cat. 6 UTP	4692	1

SOLUCIÓN MACH3

Ref. 22190



Solución Mach3	Ref.	U/Emb.
Conector RJ45 Cat. 6 UTP hembra, modelo Mach3	5843	25
Herramienta de conexión y corte rápido RJ45, modelo Mach3	22190	1

SISTEMA DE AUTOCIERRE 13 MM Y 20 MM

Ref. 8405



Sistema de Autocierre 13 mm	Ref.	U/Emb.
Sistema de autocierre 13 mm color negro	8400	25 m
Sistema de Autocierre 20 mm	Ref.	U/Emb.
Sistema de autocierre 20 mm color negro	8405	25 m

Ref. 1314

**HERRAMIENTAS DE CABLEADO ESTRUCTURADO DE COBRE Y COAXIAL**

Herramienta Pelacables	Ref.	U/Emb.
Herramientas pelacables redondos (UTP/FTP)	1314	1

Ref. 1308



Ref. 13090



Herramientas de Grimpar	Ref.	U/Emb.
Herramienta de grimpar ligera RJ45	1308	1
Herramienta profesional RJ 9/11/12/45/49	13090	1

Ref. 1410



Ref. 7663



Herramienta de Conexión y Corte 110	Ref.	U/Emb.
Herramienta de conexión y corte tipo Krone	7663	1
Herramienta de conexión y corte 110	1410	1

Ref. 14130



Téster de Cableado	Ref.	U/Emb.
Téster de cableado RJ45 UTP/FTP	14110	1
Téster ultra rápido RJ45 UTP/FTP, RJ11, RJ12, BNC, USB	14130	1

Ref. 14020



Verificador de Redes de Cobre	Ref.	U/Emb.
Cable Tracer + Téster + Generador de Tonos	14020	1

Ref. 15209



Certificador de Redes de Cobre (marca Fluke Networks)	Ref.	U/Emb.
DSX-602 500 MHZ CABLEANALYZER V2 Modelo solo de cobre con WIFI	15209	1
DSX-602- PRO 500 MHZ CABLEANALYZER PRO V2 con WIFI y con conjunto Permanent Link Adapter DSX-PLA004S. Modelo solo de cobre	15210	1

Ref. 13095



Estuche de Herramientas de Cableado	Ref.	U/Emb.
Estuche de herramientas cableado	13095	1

El estuche de herramientas de cableado incluye el téster de cableado, la herramienta de grimpar ligera, la herramienta pelacables y la herramienta de inserción 110.

Ref. 1320



Maletín de Herramientas de Cableado	Ref.	U/Emb.
Maletín de herramientas cableado	1320	1

El maletín de Herramientas de Cableado incluye el téster de cableado, la herramienta de grimpar ligera, la herramienta pelacables y la herramienta de inserción 110.

Ref. 40067



Ref. 40068



Herramientas Manuales para Cables Coaxiales	Ref.	U/Emb.
Herramienta crimpar conectores RG58/59/62/Fibra	40067	1
Herramienta pelar coaxiales, de 3 cuchillas	40068	1

Alicates Cortahilos de Precisión	Ref.	U/Emb.
Alicates cortahilos de precisión	13096	1



La mejor inversión para las redes 10 Gbps de próxima generación

U/UTP | F/UTP | F/FTP

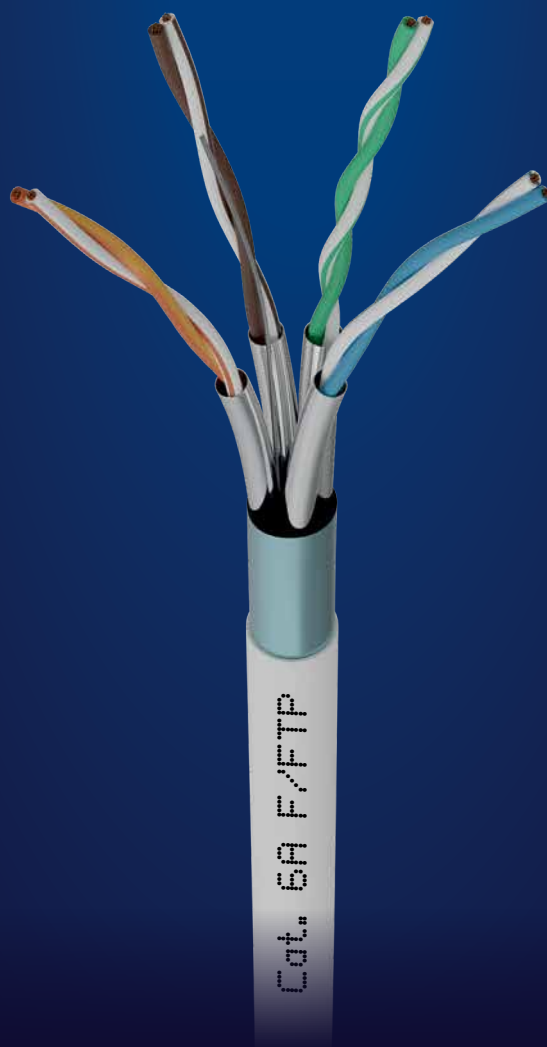

Configura tus proyectos en:
mynet.openetics.com

OPENETICS
Voz y Datos

Ref. 47010



CONECTIVIDAD EN PUESTOS DE TRABAJO

Caja de Empotrar ROUNDBox	Ref.	U/Emb.
Caja de empotrar ROUNDBox 12: 1 schuko + 2 slots	47010	1

No incluye conectores.

Ref. 47017



Cajas de Empotrar EMBox	Ref.	U/Emb.
Caja de empotrar EMBox 22: 2 schuko + 2 slots	47013	1
Caja de empotrar EMBox 24: 2 schuko + 4 slots	47016	1
Caja de empotrar EMBox 36: 3 schuko + 6 slots	47015	1
Caja de empotrar EMBox 46: 4 schuko + 6 slots	47017	1

No incluye conectores.

Otras composiciones bajo demanda.

Ref. 4837



Accesorios para Cajas de Empotrar	Ref.	U/Emb.
Conector hembra 3 polos sin carcasa antitirón negro	4714	1
Conector macho 3 polos sin carcasa antitirón negro	4716	1
Latiguillo 3 polos 3G 1,5 mm H-schuko PVC 2 m	4837	1

Ref. 50045



MÓDULOS VGA / AUDIO / KEYSTONE

Módulos VGA / Audio / Keystone	Ref.	U/Emb.
Módulo ciego	50000	1
Módulo 2 keystones vacíos	50047	1
Módulo VGA	50045	1
Módulo VGA + audio	50046	1

Ref. 50047



PUNTOS DE CONSOLIDACIÓN

Puntos de Consolidación	Ref.	U/Emb.
¡Nuevo! Punto de consolidación para 4 keystone. Montaje suelo, techo o pared.	12275	1
Punto de consolidación para 6 keystone. Montaje suelo, techo o pared	12267	1
Punto de consolidación para 12 keystone. Montaje suelo, techo o pared	12268	1
¡Nuevo! Punto de consolidación para 24 keystone. Montaje suelo, techo o pared.	12274	1
Punto de consolidación corriente 1E/5S, con conectores Wieland, para techo o falso suelo	12269	1
Punto de consolidación corriente 1E/7S, con conectores Wieland, para techo o falso suelo	12270	1

Ref. 12269

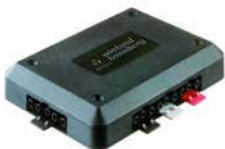

Ref. 12270



CAJAS DE SUPERFICIE, DE EMPOTRAR Y TERMINALES FALSO SUELO

Ref. 12253



Ref. 12256



Ref. 12257



Ref. 12261



Ref. 12263



Ref. 12266



Cajas de Superficie	Ref.	U/Emb.
Caja 132*76*62 superficie para 4 keystone c/antipolvo	12253	1
Caja 132*115*62 superficie para 2 keystone c/antipolvo + 2 bases schuko blancas	12254	1
Caja 132*115*62 superficie para 4 keystone c/antipolvo + 2 bases schuko blancas	12255	1
Caja 132*170*62 superficie para 2 keystone c/antipolvo + 2 bases schuko blancas + 2 bases schuko rojas	12256	1
Caja 132*170*62 superficie para 4 keystone c/antipolvo + 2 bases schuko blancas + 2 bases schuko rojas	12257	1
Cajas de Empotrar	Ref.	U/Emb.
Caja 144*129*60 empotrar para 2 keystone c/antipolvo + 2 bases schuko blancas	12261	1
Caja 144*129*60 empotrar para 4 keystone c/antipolvo + 2 bases schuko blancas	12262	1
Caja 144*185*60 empotrar para 2 keystone c/antipolvo + 2 bases schuko blancas + 2 bases schuko rojas	12263	1
Caja 144*185*60 empotrar para 4 keystone c/antipolvo + 2 bases schuko blancas + 2 bases schuko rojas	12264	1
Cajas Terminales Falso Suelo	Ref.	U/Emb.
Caja terminal falso suelo, 225*185*90 con 4 bases schuko blancas, para 1 a 4 keystone	12265	1
Caja terminal falso suelo, 225*185*90 con 2 bases schuko blancas + 2 bases schuko rojas, para 1 a 4 keystone	12266	1

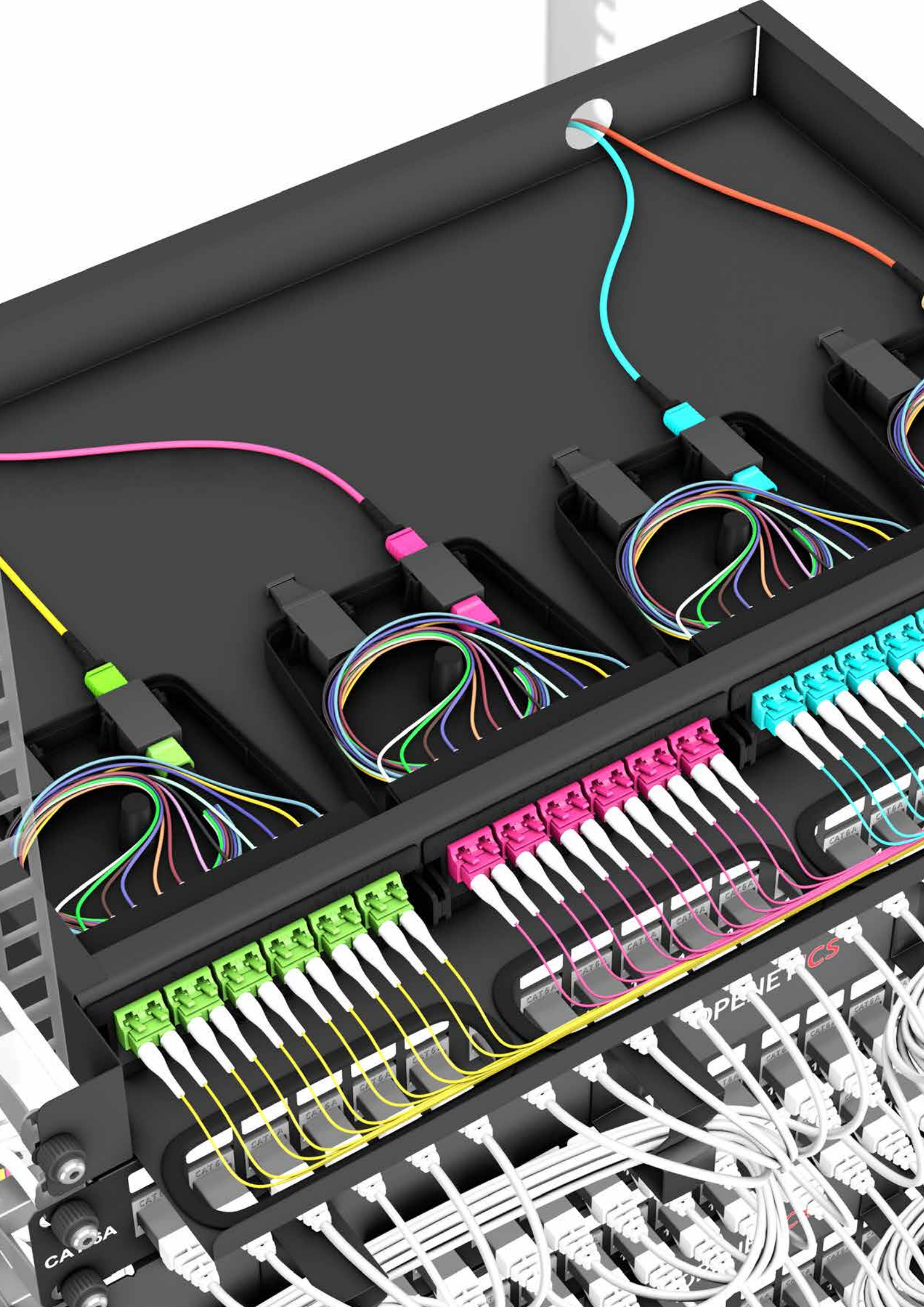

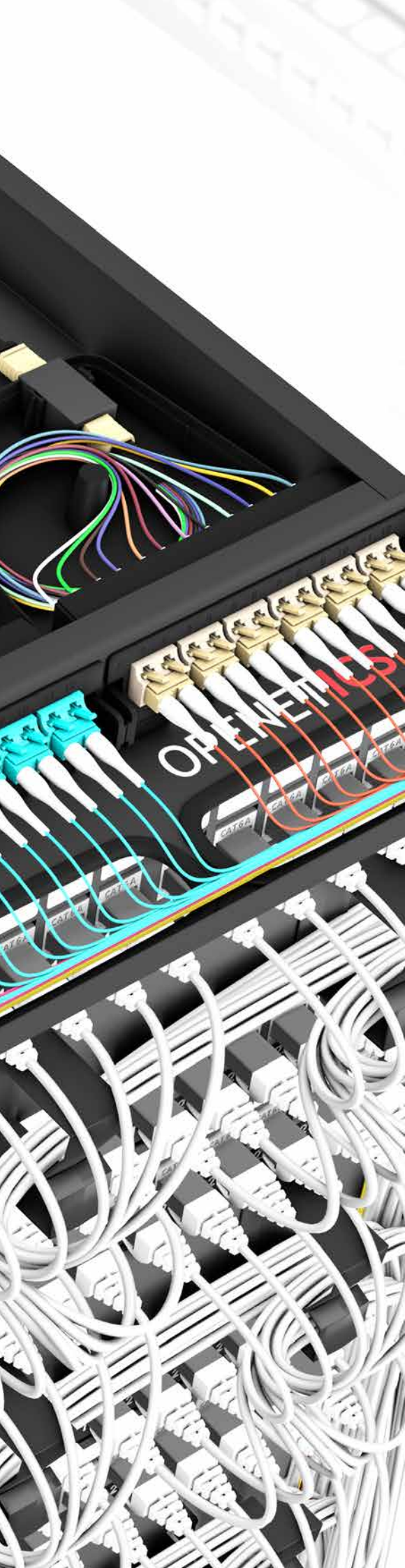

Sistemas de Cableado Estructurado de Fibra Óptica

Fibra óptica multimodo	20
Fibra óptica monomodo	30
Troncales de fibra óptica MPO (Multifiber Push On)	33
Cajas distribuidoras, cajas terminales y cajas de empalme	34
Productos modulares para carril DIN	35
Convertidores de fibra óptica	36
Reflectómetros ópticos OTDR	36
Medidores de fibra óptica y de ICT-2	37
Herramientas de fusión e instalación	38

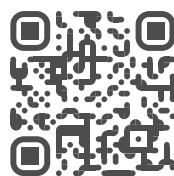

Configura tus troncales de fibra óptica con el módulo myNET Campus

mynet.openetics.com



CABLE FIBRA ÓPTICA MULTIMODO ARMADO DIELECTRICO Cca LSZH

Cables Fibra Óptica Multimodo OM1 Armado Dieléctrico Cca LSZH 62,5/125 µm Estructura Holgado	Ref.	U/Emb.
Cable Fibra Óptica Armado Dieléctrico Cca s1a,d1,a1 LSZH 62,5/125 µm OM1 4 fibras	05100	1
Cable Fibra Óptica Armado Dieléctrico Cca s1a,d1,a1 LSZH 62,5/125 µm OM1 6 fibras	05101	1
Cable Fibra Óptica Armado Dieléctrico Cca s1a,d1,a1 LSZH 62,5/125 µm OM1 8 fibras	05102	1
Cable Fibra Óptica Armado Dieléctrico Cca s1a,d1,a1 LSZH 62,5/125 µm OM1 12 fibras	05103	1
Cable Fibra Óptica Armado Dieléctrico Cca s1a,d1,a1 LSZH 62,5/125 µm OM1 16 fibras	05104	1
Cable Fibra Óptica Armado Dieléctrico Cca s1a,d1,a1 LSZH 62,5/125 µm OM1 24 fibras	05105	1

CPR

Ref. 05103

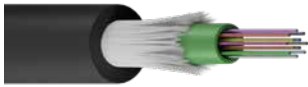

fibra óptica MM

Cables Fibra Óptica Multimodo OM2 Armado Dieléctrico Cca LSZH 50/125 µm Estructura Holgado	Ref.	U/Emb.
¡Nuevo! Cable Fibra Óptica Armado Dieléctrico Cca s1a,d0,a1 LSZH 50/125 µm OM2 4 fibras	05180	1
¡Nuevo! Cable Fibra Óptica Armado Dieléctrico Cca s1a,d0,a1 LSZH 50/125 µm OM2 6 fibras	05181	1
¡Nuevo! Cable Fibra Óptica Armado Dieléctrico Cca s1a,d0,a1 LSZH 50/125 µm OM2 8 fibras	05182	1
¡Nuevo! Cable Fibra Óptica Armado Dieléctrico Cca s1a,d0,a1 LSZH 50/125 µm OM2 12 fibras	05183	1
¡Nuevo! Cable Fibra Óptica Armado Dieléctrico Cca s1a,d0,a1 LSZH 50/125 µm OM2 16 fibras	05184	1
¡Nuevo! Cable Fibra Óptica Armado Dieléctrico Cca s1a,d0,a1 LSZH 50/125 µm OM2 24 fibras	05185	1

CPR

Ref. 05183

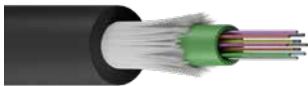

CABLE FIBRA ÓPTICA MULTIMODO ARMADO DIELECTRICO Cca LSZH

Cables Fibra Óptica Multimodo OM3 Armado Dieléctrico Cca LSZH 50/125 µm Estructura Holgado	Ref.	U/Emb.
¡Nuevo! Cable Fibra Óptica Armado Dieléctrico Cca s1a,d0,a1 LSZH 50/125 µm OM3 4 fibras	05160	1
¡Nuevo! Cable Fibra Óptica Armado Dieléctrico Cca s1a,d0,a1 LSZH 50/125 µm OM3 6 fibras	05161	1
¡Nuevo! Cable Fibra Óptica Armado Dieléctrico Cca s1a,d0,a1 LSZH 50/125 µm OM3 8 fibras	05162	1
¡Nuevo! Cable Fibra Óptica Armado Dieléctrico Cca s1a,d0,a1 LSZH 50/125 µm OM3 12 fibras	05163	1
¡Nuevo! Cable Fibra Óptica Armado Dieléctrico Cca s1a,d0,a1 LSZH 50/125 µm OM3 16 fibras	05164	1
¡Nuevo! Cable Fibra Óptica Armado Dieléctrico Cca s1a,d0,a1 LSZH 50/125 µm OM3 24 fibras	05165	1

CPR

Ref. 05163

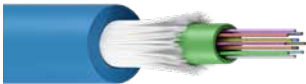

Cables Fibra Óptica Multimodo OM4 Armado Dieléctrico Cca LSZH 50/125 µm Estructura Holgado	Ref.	U/Emb.
¡Nuevo! Cable Fibra Óptica Armado Dieléctrico Cca s1a,d0,a1 LSZH 50/125 µm OM4 4 fibras	05150	1
¡Nuevo! Cable Fibra Óptica Armado Dieléctrico Cca s1a,d0,a1 LSZH 50/125 µm OM4 6 fibras	05151	1
¡Nuevo! Cable Fibra Óptica Armado Dieléctrico Cca s1a,d0,a1 LSZH 50/125 µm OM4 8 fibras	05152	1
¡Nuevo! Cable Fibra Óptica Armado Dieléctrico Cca s1a,d0,a1 LSZH 50/125 µm OM4 12 fibras	05153	1
¡Nuevo! Cable Fibra Óptica Armado Dieléctrico Cca s1a,d0,a1 LSZH 50/125 µm OM4 16 fibras	05154	1
¡Nuevo! Cable Fibra Óptica Armado Dieléctrico Cca s1a,d0,a1 LSZH 50/125 µm OM4 24 fibras	05155	1

CPR

Ref. 05153



CABLE FIBRA ÓPTICA MULTIMODO ARMADO DIELECTRICO Dca LSZH

Cables Fibra Óptica Multimodo OM1 Armado Dieléctrico Dca LSZH 62,5/125 µm Estructura Holgado	Ref.	U/Emb.
Cable Fibra Óptica armado dieléctrico Dca s1a, d1, a1 LSZH 62,5/125 µm OM1 4 fibras	05050	1
Cable Fibra Óptica armado dieléctrico Dca s1a, d1, a1 LSZH 62,5/125 µm OM1 6 fibras	05051	1
Cable Fibra Óptica armado dieléctrico Dca s1a, d1, a1 LSZH 62,5/125 µm OM1 8 fibras	05052	1
Cable Fibra Óptica armado dieléctrico Dca s1a, d1, a1 LSZH 62,5/125 µm OM1 12 fibras	05053	1
Cable Fibra Óptica armado dieléctrico Dca s1a, d1, a1 LSZH 62,5/125 µm OM1 16 fibras	05054	1
Cable Fibra Óptica armado dieléctrico Dca s1a, d1, a1 LSZH 62,5/125 µm OM1 24 fibras	05055	1

CPR

Ref. 05053



Cables Fibra Óptica Multimodo OM2 Armado Dieléctrico Dca LSZH 50/125 µm Estructura Holgado	Ref.	U/Emb.
Cable Fibra Óptica Armado Dieléctrico Dca s1a, d1, a1 LSZH 50/125 µm OM2 4 fibras	05060	1
Cable Fibra Óptica Armado Dieléctrico Dca s1a, d1, a1 LSZH 50/125 µm OM2 6 fibras	05061	1
Cable Fibra Óptica Armado Dieléctrico Dca s1a, d1, a1 LSZH 50/125 µm OM2 8 fibras	05062	1
Cable Fibra Óptica Armado Dieléctrico Dca s1a, d1, a1 LSZH 50/125 µm OM2 12 fibras	05063	1
Cable Fibra Óptica Armado Dieléctrico Dca s1a, d1, a1 LSZH 50/125 µm OM2 16 fibras	05064	1
Cable Fibra Óptica Armado Dieléctrico Dca s1a, d1, a1 LSZH 50/125 µm OM2 24 fibras	05065	1

CPR

Ref. 05063



fibra óptica MM

CABLE FIBRA ÓPTICA MULTIMODO ARMADO DIELECTRICO Dca LSZH

Cables Fibra Óptica Multimodo OM3 Armado Dieléctrico Dca LSZH 50/125 µm Estructura Holgado	Ref.	U/Emb.
Cable Fibra Óptica Armado Dieléctrico Dca s1a, d1, a1 LSZH 50/125 µm OM3 4 fibras	05070	1
Cable Fibra Óptica Armado Dieléctrico Dca s1a, d1, a1 LSZH 50/125 µm OM3 6 fibras	05071	1
Cable Fibra Óptica Armado Dieléctrico Dca s1a, d1, a1 LSZH 50/125 µm OM3 8 fibras	05072	1
Cable Fibra Óptica Armado Dieléctrico Dca s1a, d1, a1 LSZH 50/125 µm OM3 12 fibras	05073	1
Cable Fibra Óptica Armado Dieléctrico Dca s1a, d1, a1 LSZH 50/125 µm OM3 16 fibras	05074	1
Cable Fibra Óptica Armado Dieléctrico Dca s1a, d1, a1 LSZH 50/125 µm OM3 24 fibras	05075	1

CPR

Ref. 05073

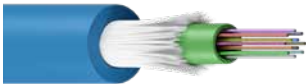

Cables Fibra Óptica Multimodo OM4 Armado Dieléctrico Dca LSZH 50/125 µm Estructura Holgado	Ref.	U/Emb.
Cable Fibra Óptica Armado Dieléctrico Dca s1a, d1, a1 LSZH 50/125 µm OM4 4 fibras	05080	1
Cable Fibra Óptica Armado Dieléctrico Dca s1a, d1, a1 LSZH 50/125 µm OM4 6 fibras	05081	1
Cable Fibra Óptica Armado Dieléctrico Dca s1a, d1, a1 LSZH 50/125 µm OM4 8 fibras	05082	1
Cable Fibra Óptica Armado Dieléctrico Dca s1a, d1, a1 LSZH 50/125 µm OM4 12 fibras	05083	1
Cable Fibra Óptica Armado Dieléctrico Dca s1a, d1, a1 LSZH 50/125 µm OM4 16 fibras	05084	1
Cable Fibra Óptica Armado Dieléctrico Dca s1a, d1, a1 LSZH 50/125 µm OM4 24 fibras	05085	1

CPR

Ref. 05082



CABLE FIBRA ÓPTICA MULTIMODO ARMADO DIELECTRICO Eca LSZH

Cables Fibra Óptica Multimodo OM1 Armado Dieléctrico Eca LSZH 62,5/125 µm Estructura Holgado	Ref.	U/Emb.
Cable Fibra Óptica armado dieléctrico Eca LSZH 62,5/125 µm 4 fibras	05011	1
Cable Fibra Óptica armado dieléctrico Eca LSZH 62,5/125 µm 6 fibras	05012	1
Cable Fibra Óptica armado dieléctrico Eca LSZH 62,5/125 µm 8 fibras	05013	1
Cable Fibra Óptica armado dieléctrico Eca LSZH 62,5/125 µm 12 fibras	05014	1
Cable Fibra Óptica armado dieléctrico Eca LSZH 62,5/125 µm 16 fibras	05017	1
Cable Fibra Óptica armado dieléctrico Eca LSZH 62,5/125 µm 24 fibras	05016	1

CPR

Ref. 05014

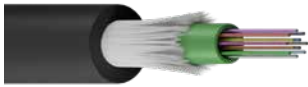

Cables Fibra Óptica Multimodo OM2 Armado Dieléctrico Eca LSZH 50/125 µm Estructura Holgado	Ref.	U/Emb.
Cable Fibra Óptica armado dieléctrico Eca LSZH 50/125 µm 4 fibras	04905	1
Cable Fibra Óptica armado dieléctrico Eca LSZH 50/125 µm 6 fibras	04906	1
Cable Fibra Óptica armado dieléctrico Eca LSZH 50/125 µm 8 fibras	04907	1
Cable Fibra Óptica armado dieléctrico Eca LSZH 50/125 µm 12 fibras	04908	1
Cable Fibra Óptica armado dieléctrico Eca LSZH 50/125 µm 16 fibras	04909	1
Cable Fibra Óptica armado dieléctrico Eca LSZH 50/125 µm 24 fibras	04910	1

CPR

Ref. 04908

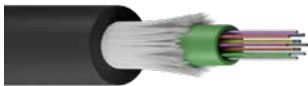

fibra óptica MM

CABLE FIBRA ÓPTICA MULTIMODO ARMADO DIELECTRICO Eca LSZH

Cables Fibra Óptica Multimodo OM3 Armado Dieléctrico Eca LSZH 50/125 µm con Estructura Holgado	Ref.	U/Emb.
Cable Fibra Óptica armado dieléctrico Eca LSZH 50/125 µm 4 fibras	04994	1
Cable Fibra Óptica armado dieléctrico Eca LSZH 50/125 µm 6 fibras	04995	1
Cable Fibra Óptica armado dieléctrico Eca LSZH 50/125 µm 8 fibras	04996	1
Cable Fibra Óptica armado dieléctrico Eca LSZH 50/125 µm 12 fibras	04997	1
Cable Fibra Óptica armado dieléctrico Eca LSZH 50/125 µm 16 fibras	04998	1
Cable Fibra Óptica armado dieléctrico Eca LSZH 50/125 µm 24 fibras	04999	1

CPR

Ref. 04997

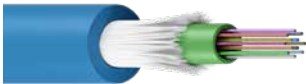

Cables Fibra Óptica Multimodo OM4 Armado Dieléctrico Eca LSZH 50/125 µm con Estructura Holgado	Ref.	U/Emb.
Cable Fibra Óptica armado dieléctrico Eca LSZH 50/125 µm 4 fibras	05040	1
Cable Fibra Óptica armado dieléctrico Eca LSZH 50/125 µm 6 fibras	05041	1
Cable Fibra Óptica armado dieléctrico Eca LSZH 50/125 µm 8 fibras	05042	1
Cable Fibra Óptica armado dieléctrico Eca LSZH 50/125 µm 12 fibras	05043	1
Cable Fibra Óptica armado dieléctrico Eca LSZH 50/125 µm 16 fibras	05044	1
Cable Fibra Óptica armado dieléctrico Eca LSZH 50/125 µm 24 fibras	05045	1

CPR

Ref. 05043



CABLE FIBRA ÓPTICA MULTIMODO ARMADO METÁLICO

Cables Fibra Óptica Multimodo OM1 Armado Metálico 62,5/125 μm Estructura Holgado	Ref.	U/Emb.
Cable Fibra Óptica armado metálico 62,5/125 μm 4 fibras	05021	1
Cable Fibra Óptica armado metálico 62,5/125 μm 6 fibras	05022	1
Cable Fibra Óptica armado metálico 62,5/125 μm 8 fibras	05024	1
Cable Fibra Óptica armado metálico 62,5/125 μm 12 fibras	05025	1
Cable Fibra Óptica armado metálico 62,5/125 μm 16 fibras	05029	1
Cable Fibra Óptica armado metálico 62,5/125 μm 24 fibras	05027	1

Ref. 05025



Cable Fibra Óptica Multimodo OM2 Armado Metálico Fca 50/125 μm Estructura Holgado	Ref.	U/Emb.
Cable Fibra Óptica armado metálico Fca 50/125 μm 4 fibras	14911	1
Cable Fibra Óptica armado metálico Fca 50/125 μm 6 fibras	14912	1
Cable Fibra Óptica armado metálico Fca 50/125 μm 8 fibras	14913	1
Cable Fibra Óptica armado metálico Fca 50/125 μm 12 fibras	14914	1
Cable Fibra Óptica armado metálico Fca 50/125 μm 16 fibras	14915	1
Cable Fibra Óptica armado metálico Fca 50/125 μm 24 fibras	14916	1

CPR

Ref. 14914



CABLE FIBRA ÓPTICA MULTIMODO PARA LATIGUILLOS





Cable Fibra Óptica Multimodo para Latiguillos	Ref.	U/Emb.
Cable Fibra Óptica multimodo para latiguillos LSZH 62,5/125 μm 2 fibras	5032	1



Ref. 5032





fibra óptica MM

LATIGUILLOS DE FIBRA ÓPTICA MULTIMODO [Otras medidas, consultar]

Latiguillos de Fibra Óptica Multimodo OM1 62,5/125 µm Pulido PC		Ref.	U/Emb.
 <p>Ref. 5078</p>  <p>Ref. 5062</p> <p>Ref. 5074</p>  <p>Ref. 5072</p> 	Latiguillo bifibra SC-SC 62,5/125 2 m	5078	1
	Latiguillo bifibra ST-ST 62,5/125 2 m	5062	1
	Latiguillo bifibra ST-SC 62,5/125 2 m	5074	1
	Latiguillo bifibra LC-SC 62,5/125 2 m	4917	1
	Latiguillo bifibra ST-LC 62,5/125 2 m	4918	1
	Latiguillo bifibra MTRJ-MTRJ 62,5/125 2 m	5070	1
	Latiguillo bifibra MTRJ-SC 62,5/125 2 m	5071	1
	Latiguillo bifibra MTRJ-ST 62,5/125 2 m	5072	1
	Latiguillo bifibra LC-LC 62,5/125 2 m	4919	1

Latiguillos de Fibra Óptica Multimodo OM2 50/125 µm Pulido PC		Ref.	U/Emb.
 <p>Ref. 5072</p> 	Latiguillo bifibra SC-SC 50/125 2 m	4920	1
	Latiguillo bifibra ST-ST 50/125 2 m	4921	1
	Latiguillo bifibra ST-SC 50/125 2 m	4922	1
	Latiguillo bifibra MTRJ-MTRJ 50/125 2 m	4923	1
	Latiguillo bifibra MTRJ-SC 50/125 2 m	4924	1
	Latiguillo bifibra MTRJ-ST 50/125 2 m	4925	1
	Latiguillo bifibra LC-SC 50/125 2 m	4926	1
	Latiguillo bifibra ST-LC 50/125 2 m	4927	1
	Latiguillo bifibra LC-LC 50/125 2 m	4928	1

Latiguillos de Fibra Óptica Multimodo OM3 50/125 µm Pulido PC		Ref.	U/Emb.
 <p>Ref. 4933</p>	Latiguillo bifibra SC-SC 50/125 2 m	4929	1
	Latiguillo bifibra ST-ST 50/125 2 m	5176	1
	Latiguillo bifibra ST-SC 50/125 2 m	5156	1
	Latiguillo bifibra LC-SC 50/125 2 m	4933	1
	Latiguillo bifibra LC-LC 50/125 2 m	4930	1
	Latiguillo bifibra ST-LC 50/125 2 m	4937	1

Latiguillos de Fibra Óptica Multimodo OM4 50/125 µm Pulido PC		Ref.	U/Emb.
 <p>Ref. 50690</p>	Latiguillo bifibra LC-LC 50/125 2 m	50690	1
	Latiguillo bifibra LC-SC 50/125 2 m	50695	1
	¡Nuevo! Latiguillo bifibra ST-LC 50/125 2m	50697	1
	¡Nuevo! Latiguillo bifibra ST-SC 50/125 2m	50698	1
	¡Nuevo! Latiguillo bifibra SC-SC 50/125 2m	50696	1

CONECTORES PREPULIDOS “FAST” PARA FIBRA ÓPTICA

Ref. 51029



Conectores FAST para Fibra Óptica Multimodo OM1	Ref.	U/Emb.
Conector FAST multimodo OM1 SC pulido PC 62,5/125 0,9 mm	51029	1

Conectores FAST para Fibra Óptica Multimodo OM2	Ref.	U/Emb.
Conector FAST multimodo OM2 SC pulido PC 50/125 3 mm	51028	1

Conectores FAST para Fibra Óptica Multimodo OM3	Ref.	U/Emb.
Conector FAST multimodo OM3 SC pulido PC 50/125 OM3 0,9 mm	51034	1
Conector FAST multimodo OM3 LC pulido PC 50/125 OM3 0,9 mm	51033	1

Microtubo para conectores FAST	Ref.	U/Emb.
¡Nuevo! Microtubo 900/250 um para conector FAST 0,9 mm (10 m)	51035	1

EMPALMES MECÁNICOS

Ref. 50481



Empalme Mecánico	Ref.	U/Emb.
Empalme mecánico para cassette FO (250 µm y 900 µm)	50481	20

PASAMUROS PARA FIBRA ÓPTICA MULTIMODO

Ref. 5076



Pasamuros Multimodo	Ref.	U/Emb.
Pasamuro multimodo OM2 ST/ST simple	5055	1
Pasamuro multimodo OM2 SC/SC simple	5076	1
Pasamuro multimodo OM2 FC/FC simple	5079	1
Pasamuro multimodo OM2 ST/ST doble	5101	1
Pasamuro multimodo OM2 SC/SC doble	5060	1
Pasamuro multimodo OM2 SC/ST doble	5050	1
Pasamuro multimodo OM2 LC/LC doble	5087	1
¡Nuevo! Pasamuro multimodo OM3 SC/SC simple	5089	1
¡Nuevo! Pasamuro multimodo OM3 SC/SC doble	5090	1
¡Nuevo! Pasamuro multimodo OM3 LC/LC doble	5093	1
¡Nuevo! Pasamuro multimodo OM4 SC/SC simple	5489	1
¡Nuevo! Pasamuro multimodo OM4 SC/SC doble	5490	1
¡Nuevo! Pasamuro multimodo OM4 LC/LC doble	5493	1

Ref. 5090



Ref. 5493



PIGTAILS MULTIMODO

Ref. 5061



Pigtail Multimodo OM1 [62,5/125 μm] Pulido PC	Ref.	U/Emb.
Pigtail multimodo OM1 ST de 1 m	5061	1
Pigtail multimodo OM1 SC de 1 m	5163	1
Pigtail multimodo OM1 LC de 1 m	5158	1

Ref. 5159



Pigtail Multimodo OM2 [50/125 μm] Pulido PC	Ref.	U/Emb.
Pigtail multimodo OM2 ST de 1 m	50551	1
Pigtail multimodo OM2 SC de 1 m	5159	1
Pigtail multimodo OM2 LC de 1 m	50550	1

Ref. 50560



Pigtail Multimodo OM3 [50/125 μm] Pulido PC	Ref.	U/Emb.
Pigtail multimodo OM3 SC de 1 m	5160	1
Pigtail multimodo OM3 LC de 1 m	50560	1

Ref. 50575



Pigtail Multimodo OM4 [50/125 μm] Pulido PC	Ref.	U/Emb.
Pigtail multimodo OM4 SC de 1 m	50578	1
Pigtail multimodo OM4 LC de 1 m	50575	1

CABLE FIBRA ÓPTICA MONOMODO ARMADO DIELECTRICO Cca LSZH

Cables Fibra Óptica Monomodo OS2 Armado Dieléctrico Cca LSZH 9/125 µm Estructura Holgado	Ref.	U/Emb.
¡Nuevo! Cable Fibra Óptica Armado Dieléctrico Cca s1a,d0,a1 LSZH 9/125 µm OS2 4 fibras	05170	1
¡Nuevo! Cable Fibra Óptica Armado Dieléctrico Cca s1a,d0,a1 LSZH 9/125 µm OS2 6 fibras	05171	1
¡Nuevo! Cable Fibra Óptica Armado Dieléctrico Cca s1a,d0,a1 LSZH 9/125 µm OS2 8 fibras	05172	1
¡Nuevo! Cable Fibra Óptica Armado Dieléctrico Cca s1a,d0,a1 LSZH 9/125 µm OS2 12 fibras	05173	1
¡Nuevo! Cable Fibra Óptica Armado Dieléctrico Cca s1a,d0,a1 LSZH 9/125 µm OS2 16 fibras	05174	1
¡Nuevo! Cable Fibra Óptica Armado Dieléctrico Cca s1a,d0,a1 LSZH 9/125 µm OS2 24 fibras	05175	1

CPR

Ref. 05173



fibra óptica SM

CABLE FIBRA ÓPTICA MONOMODO ARMADO DIELECTRICO Dca LSZH

Cables Fibra Óptica Monomodo OS2 Armado Dieléctrico Dca LSZH 9/125 µm Estructura Holgado	Ref.	U/Emb.
Cable Fibra Óptica Armado Dieléctrico Dca s2,d2,a1 LSZH 9/125 µm OS2 4 fibras	05090	1
Cable Fibra Óptica Armado Dieléctrico Dca s2,d2,a1 LSZH 9/125 µm OS2 6 fibras	05091	1
Cable Fibra Óptica Armado Dieléctrico Dca s2,d2,a1 LSZH 9/125 µm OS2 8 fibras	05092	1
Cable Fibra Óptica Armado Dieléctrico Dca s2,d2,a1 LSZH 9/125 µm OS2 12 fibras	05093	1
Cable Fibra Óptica Armado Dieléctrico Dca s2,d2,a1 LSZH 9/125 µm OS2 16 fibras	05094	1
Cable Fibra Óptica Armado Dieléctrico Dca s2,d2,a1 LSZH 9/125 µm OS2 24 fibras	05095	1

CPR

Ref. 05093



CABLE FIBRA ÓPTICA MONOMODO ARMADO DIELECTRICO Eca LSZH

Cables Fibra Óptica Monomodo OS2 Armado Dieléctrico Eca LSZH 9/125 µm Estructura Holgado	Ref.	U/Emb.
Cable Fibra Óptica armado dieléctrico Eca LSZH 9/125 µm 4 fibras	04940	1
Cable Fibra Óptica armado dieléctrico Eca LSZH 9/125 µm 6 fibras	04941	1
Cable Fibra Óptica armado dieléctrico Eca LSZH 9/125 µm 8 fibras	04942	1
Cable Fibra Óptica armado dieléctrico Eca LSZH 9/125 µm 12 fibras	04943	1
Cable Fibra Óptica armado dieléctrico Eca LSZH 9/125 µm 16 fibras	04944	1
Cable Fibra Óptica armado dieléctrico Eca LSZH 9/125 µm 24 fibras	04945	1

CPR

Ref. 04943

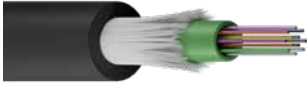
**CABLE FIBRA ÓPTICA MONOMODO ARMADO METÁLICO OS2**

¡Nuevos! Cables Fibra Óptica Monomodo OS2 Armado Metálico Fca 9/125 µm Estructura Holgado	Ref.	U/Emb.
Cable Fibra Óptica armado metálico Fca 9/125 µm 4 fibras	14950	1
Cable Fibra Óptica armado metálico Fca 9/125 µm 6 fibras	14951	1
Cable Fibra Óptica armado metálico Fca 9/125 µm 8 fibras	14952	1
Cable Fibra Óptica armado metálico Fca 9/125 µm 12 fibras	14953	1
Cable Fibra Óptica armado metálico Fca 9/125 µm 16 fibras	14954	1
Cable Fibra Óptica armado metálico Fca 9/125 µm 24 fibras	14955	1

CPR

Ref. 14953

**LATIGUILLOS DE FIBRA ÓPTICA MONOMODO** *[Otras medidas, consultar]*

Latiguillos de Fibra Óptica Monomodo OS2 9/125 µm	Ref.	U/Emb.
Latiguillo bifibra SC-PC/SC-PC 9/125 2 m	5168	1
Latiguillo bifibra SC-PC/SC-APC 9/125 2 m	5171	1
Latiguillo bifibra SC-APC/LC-PC 9/125 2 m	5184	1
Latiguillo bifibra LC-PC/LC-PC 9/125 2 m	5065	1
Latiguillo bifibra FC-PC/SC-APC 9/125 2 m	5186	1
Latiguillo bifibra FC-PC/FC-PC 9/125 2 m	5185	1
Latiguillo bifibra ST-PC/ST-PC 9/125 2 m	5149	1
Latiguillo bifibra FC-PC/SC-PC 9/125 2 m	5183	1
Latiguillo bifibra SC-PC/LC-PC 9/125 2 m	5155	1
Latiguillo bifibra FC-PC/LC-PC 9/125 2 m	5153	1
Latiguillo bifibra SC-APC/SC-APC 9/125 2 m	5161	1
Latiguillo bifibra ST-PC/LC-PC 9/125 2 m	5169	1

Ref. 5149



Ref. 5161



CONECTORES PREPULIDOS MONOMODO “FAST” PARA FIBRA ÓPTICA



Conectores FAST para Fibra Óptica Monomodo OS2	Ref.	U/Emb.
Conector FAST monomodo OS2 SC pulido APC 9/125 μm 3 mm	51031	1
Conector FAST monomodo OS2 SC pulido APC 9/125 μm 0,9 mm	51030	1
Conector FAST monomodo OS2 LC pulido SPC 9/125 0,9 mm	51032	1

PASAMUROS PARA FIBRA ÓPTICA MONOMODO



Pasamuros Monomodo OS2	Ref.	U/Emb.
Pasamuro monomodo OS2 ST/ST simple	50500	1
Pasamuro monomodo OS2 SC/SC simple	50502	1
Pasamuro monomodo OS2 FC/FC simple	50505	1
Pasamuro monomodo OS2 SC/SC pulido APC simple	50506	1
Pasamuro monomodo OS2 SC/SC pulido APC simple con tapa	50513	1
Pasamuro monomodo OS2 LC/LC doble	5086	1
Pasamuro monomodo OS2 ST/ST doble	50501	1
Pasamuro monomodo OS2 SC/SC doble	50503	1
Pasamuro monomodo OS2 SC/SC pulido APC doble	50507	1
Pasamuro monomodo OS2 SC/ST doble	50504	1

PIGTAILS MONOMODO

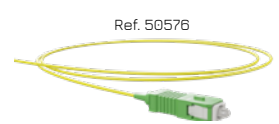
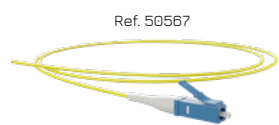

Pigtail Monomodo OS2 [9/125 μm] Pulido PC/APC	Ref.	U/Emb.
Pigtail monomodo OS2 ST de 2 m	5164	1
Pigtail monomodo OS2 FC de 2 m	50584	1
Pigtail monomodo OS2 SC de 1 m	50566	1
Pigtail monomodo OS2 LC de 1 m	50567	1
Pigtail monomodo OS2 SC/APC de 1 m. Dca s1,d1,a1 G-657A2 0,9 mm	50576	1

¡NUEVOS! TRONCALES DE FIBRA ÓPTICA MPO (MULTIFIBER PUSH ON)

Ref. 50807



Ref. 50808



Ref. 50812



Ref. 50814



¡Nuevol Cables Troncales de Fibra Óptica MPO (MM /SM)	Ref.	U/Emb.
Cable troncal de fibra MPO/MPO (hembra-hembra) multimodo OM2, 12 fibras, 30 m	50807	1
Cable troncal de fibra MPO/MPO (hembra-hembra) multimodo OM3, 12 fibras, 30 m	50808	1
Cable troncal de fibra MPO/MPO (hembra-hembra) multimodo OM4, 12 fibras, 30 m	50809	1
Cable troncal de fibra MPO/MPO (hembra-hembra) monomodo OS2, 12 fibras, 30 m	50810	1
Cable troncal de fibra MPO/MPO (hembra-hembra) multimodo OM2, 12 fibras, 60 m	50811	1
Cable troncal de fibra MPO/MPO (hembra-hembra) multimodo OM3, 12 fibras, 60 m	50812	1
Cable troncal de fibra MPO/MPO (hembra-hembra) multimodo OM4, 12 fibras, 60 m	50813	1
Cable troncal de fibra MPO/MPO (hembra-hembra) monomodo OS2, 12 fibras, 60 m	50814	1

Ref. 50801



¡Nuevol Cassete MPO (MM /SM)	Ref.	U/Emb.
Cassete MPO (macho) multimodo OM2, LC, 12 fibras	50800	1
Cassete MPO (macho) multimodo OM3, LC, 12 fibras	50801	1
Cassete MPO (macho) multimodo OM4, LC, 12 fibras	50802	1
Cassete MPO (macho) monomodo OS2, LC, 12 fibras	50803	1

Ref. 50805



¡Nuevol Patch Panel Extraíble MPO	Ref.	U/Emb.
Patch panel extraíble de fibra MPO para 4 cassettes, 1 U	50804	1
Patch panel extraíble de fibra MPO para 8 cassettes, 2 U	50805	1
Patch panel extraíble de fibra MPO para 12 cassettes, 3 U	50806	1

CAJAS DISTRIBUIDORAS, TERMINALES Y DE EMPALME ESTANCAS

Kits Cajas Distribuidoras de Fibra Óptica Extraíble*	Ref.	U/Emb.
Kit caja distribuidora de fibra óptica extraíble 19" 1 U 24 ST simplex	50401	1
Kit caja distribuidora de fibra óptica extraíble 19" 1 U 24 SC simplex	50402	1
Kit caja distribuidora de fibra óptica extraíble 19" 1 U 24 FC simplex	50404	1
Kit caja distribuidora de fibra óptica extraíble 19" 1 U 24 LC duplex	50403	1
Kit caja distribuidora de fibra óptica extraíble 19" 1 U 24 SC duplex	50407	1
Kit caja distribuidora de fibra óptica extraíble 19" 2U 48 ST simplex (2 paneles)	50410	1
Kit caja distribuidora de fibra óptica extraíble 19" 2U 48 FC simplex (2 paneles)	50411	1
Kit caja distribuidora de fibra óptica extraíble 19" 2U 48 SC duplex (96 fibras, 2 paneles)	50412	1
Kit caja distribuidora de fibra óptica extraíble 19" 2U 48 LC duplex (96 fibras, 2 paneles)	50413	1

* Los Kits no incorporan los pasamuros
 * Capacidad paneles: hasta 24 pasamuros

Caja Distribuidora de Fibra Óptica Extraíble	Ref.	U/Emb.
Caja distribuidora de fibra óptica extraíble 19" 1 U (48 fibras)	5034	1
Caja distribuidora de fibra óptica extraíble 19" 2 U (96 fibras) *	50460	1

* La Ref. 50460 admite 2 paneles extraíbles

Paneles Extraíbles para Caja Distribuidora de Fibra Óptica Extraíble	Ref.	U/Emb.
Panel extraíble para 24 pasamuros FC simple (agujero D)	5207	1
Panel extraíble para 24 pasamuros ST/ST simple	5201	1
Panel extraíble para 24 pasamuros SC/SC simple y LC/LC doble	5204	1
Panel extraíble para 16 pasamuros SC/SC, ST/ST, SC/ST doble	5036	1



Ref. 50412

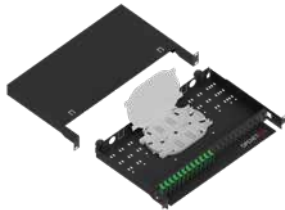

Ref. 5034



Ref. 5201



Ref. 5204



CAJAS DISTRIBUIDORAS, TERMINALES Y DE EMPALME ESTANCAS

Ref. 50461



Cajas Terminales de Fibra Óptica	Ref.	U/Emb.
Caja terminal 4 fibras para pasamuros ST (40x170x130)	5057	1
Caja terminal 4 fibras para pasamuros SC/LCD (40x170x130)	50451	1
Caja terminal 8 fibras para pasamuros SC/LCD (40x180x178)	50461	1
Caja terminal 12 fibras para pasamuros SC/LCD (50x310x230)	50462	1

Para montaje sobre carril DIN y otro tipo de conectores, consultar: Pasamuros no incluidos

Ref. 5096



Accesorios para Cajas de Fibra Óptica	Ref.	U/Emb.
Tapón ciego ST	5096	1
Tapón ciego SC/LCD	5085	1
Tapón ciego SCD	5097	1

Ref. 5097



Bridas guía fibras	5099	1
Guía fibras	5098	1

Ref. 5098



Cassette de empalme para 12/24 fusiones	5190	1
Protector termo retractil 40 mm	5114	100
Protector termo retractil 45 mm	5115	100
Protector termo retractil 60 mm	5116	100

Ref. 51200



Caja de Empalme Estanca para Fibra Óptica	Ref.	U/Emb.
Caja de empalme estanca para F/O hasta 24 fibras 3E	51223	1
Caja de empalme estanca para fibra óptica hasta 48 fibras 1E/15	51201	1
Caja de empalme estanca para fibra óptica hasta 96 fibras 2E/25	51200	1

PRODUCTOS MODULARES PARA CARRIL DIN

Ref. 50039



Módulos Fibra Óptica para Carril DIN (1 polo = 18 mm)	Ref.	U/Emb.
Módulo fibra óptica ST simple para carril DIN (pasamuro+ incluido)	50037	1
Módulo fibra óptica SC simple para carril DIN (pasamuro incluido)	50039	1
Módulo fibra óptica LC doble para carril DIN (pasamuro incluido)	50041	1

Módulos Fibra Óptica para Carril DIN (2 polos = 36 mm)	Ref.	U/Emb.
Módulo fibra óptica ST doble para carril DIN (pasamuro incluido)	50038	1
Módulo fibra óptica SC doble para carril DIN (pasamuro incluido)	50040	1

Ref. 50081



Módulos Fibra Óptica para Pasamuros	Ref.	U/Emb.
Módulo para 6 pasamuros SC Simplex o LC Duplex para montaje pared o carril DIN	50081	1
Módulo para 6 pasamuros SC Duplex o ST Duplex para montaje pared o carril DIN	50082	1
Módulo para 6 pasamuros ST para montaje pared o carril DIN	50083	1

CONVERTIDORES DE FIBRA ÓPTICA

Ref. 21410



Ref. 21433



Convertidores	Ref.	U/Emb.
Convertidor de Medio Fast Ethernet [10/100BTX-100BFX] [Multimodo Duplex SC]	21410	1
Convertidor de Medio Fast Ethernet [10/100BTX-100BFX] [Monomodo Duplex SC]	21413	1
Convertidor de Medio Gigabit Ethernet [10/100/1000 Base-TX a 1000 Base-SX] [Multimodo Duplex SC]	21430	1
Convertidor de Medio Gigabit Ethernet [10/100/1000 Base-TX a 1000 Base-SX] [Monomodo Duplex SC]	21433	1
Chasis 19" 2 U 14 slot para media converter	21450	1

Fuente de alimentación incluida.

OTDRS MULTIMODO & MONOMODO Y BOBINAS DE LANZAMIENTO

Ref. 17088



Ref. 17096



Ref. 17040



Reflectómetros Ópticos OTDR	Ref.	U/Emb.
Palm OTDR SM 1550 nm 28 dB	17087	1
Palm OTDR SM 1310/1550 nm 32/28 dB	17088	1
OTDR SM 1310/1550 nm 32/30 dB	17090	1
OTDR MM 850/1300 nm 21/19 dB	17089	1
OTDR SM 1310/1490/1550 nm 32/30/28 dB	17084	1
OTDR MM/SM 850/1310/1550 nm 21/19/30 dB	17093	1
OTDR SM 1310/1550/1625 nm 32/30/28 dB	17096	1
¡Nuevo! Plataforma OTDR Multifunción 1310/1550 nm 20/22 dB	17097	1

Bobinas de Lanzamiento Multimodo	Ref.	U/Emb.
Bobina de lanzamiento multimodo 50/125 µm 500 m. SC/PC-SC/PC	17040	1
Bobina de lanzamiento multimodo 62,5/125 µm 500 m. SC/PC-SC/PC	17041	1

Bobinas de Lanzamiento Monomodo	Ref.	U/Emb.
Bobina de lanzamiento monomodo 9/125 µm 1000 m SC/APC-SC/APC	17044	1
Bobina de lanzamiento monomodo 9/125 µm 1000 m SC/UPC-SC/UPC	17045	1
Bobina de lanzamiento monomodo 9/125 µm 1000 m SC/UPC-LC/UPC	17046	1

MEDIDORES DE FIBRA ÓPTICA ICT-2

Ref. 51290 (51268 + 81279)



Kit de Medición Avanzado FTTX Tester Dual Port GPON con VFL	Ref.	U/Emb.
---	------	--------

Kit de medición FTTX Tester Dual Port GPON con VFL	51290	1
--	-------	---

El Kit de medición FTTX **OPENETICS** incluye:

- Fuente láser triple para FTTH (Ref. 51268)
- Medidor de potencia óptica GPON con VFL (Ref. 51279)

Ref. 51291 (51268 + 81280)



Kit de Medición FTTX Tester Dual Port GPON	Ref.	U/Emb.
--	------	--------

Kit de medición FTTX Tester Dual Port GPON	51291	1
--	-------	---

El Kit de medición FTTX **OPENETICS** incluye:

- Fuente láser triple para FTTH (Ref. 51268)
- Medidor de potencia óptica GPON (Ref. 51280)

Ref. 51269



Accesorios Kit de Medición FTTX Ref. 51290 / 51291	Ref.	U/Emb.
--	------	--------

Alimentador AC/DC para GPON y fuente láser	51269	1
--	-------	---

Kit de cables de test para medidor GPON	50509	1
---	-------	---

Kit de baterías y cargador para GPON	51267	1
--------------------------------------	-------	---

MEDIDORES DE FIBRA ÓPTICA

Ref. 51292 (51271 + 81270)



Kit de Medición Monomodo	Ref.	U/Emb.
--------------------------	------	--------

Kit de medición Monomodo	51292	1
--------------------------	-------	---

El Kit de medición Monomodo **OPENETICS** incluye:

- Medidor de potencia óptica (Ref. 51271)
- Fuente Láser 1310 - 1550 nm. (Ref. 51270)

Accesorio: Kit de cables de Test para medidor de fibra óptica	51273	1
--	-------	---

Ref. 17071



Ref. 17070



Medidor de Potencia Óptica	Ref.	U/Emb.
----------------------------	------	--------

Medidor de potencia óptica	51271	1
----------------------------	-------	---

Fuente láser monomodo 1310/1550 nm	51270	1
------------------------------------	-------	---

Fuente led multimodo 850/1300 nm	51283	1
----------------------------------	-------	---

Ref. 17071



Identificador de tráfico de fibra óptica	Ref.	U/Emb.
--	------	--------

Identificador de tráfico de fibra óptica	17071	1
--	-------	---

HERRAMIENTAS DE FUSIÓN, CONECTORIZACIÓN E INSTALACIÓN DE FIBRA ÓPTICA

Ref. 14090



Fusionadoras	Ref.	U/Emb.
Kit fusionadora KF-2700	14090	1
¡Nuevo! Kit fusionadora KF-2800	14092	1

Los Kits de Fusionadoras de OPENETICS incluyen:

- Fusionadora
- Batería extraíble
- Electrodo de repuesto
- Bandeja de enfriamiento
- CD Manual de instrucciones
- Robusta maleta de protección con cierre
- Cortadora de precisión
- Peladora
- Adaptador AC y cable de alimentación



Ref. 14092



Ref. 14012



Cortadora	Ref.	U/Emb.
Cortadora de precisión FC-200	14014	1
Cortadora de precisión FC-300	14012	1

Ref. 14011



Láser VLF	Ref.	U/Emb.
Láser localizador visual de fibras	14011	1

Ref. 14010



Maletín de Montaje Conectores FAST	Ref.	U/Emb.
Maletín de montaje conectores FAST	14010	1

El maletín contiene:

- Cortadora de precisión
- Peladora para fibra óptica
- Tijera especial corte Kevlar
- Set 50 toallitas de alcohol para limpieza
- Rotulador
- Contenedor conectores FAST
- Gafas de protección
- Lámpara frontal de leds
- Maletín de plástico para transporte

HERRAMIENTAS DE FUSIÓN, CONECTORIZACIÓN E INSTALACIÓN DE FIBRA ÓPTICA

Consumibles de Fibra Óptica		Ref.	U/Emb.		
Ref. 17069		Ref. 17070	¡Nuevo! Alcohol isopropílico (bote 1.000 cc)	50940	1
			Caja de servilletas para limpiar conectores (pack 280)	5092	1
			Limpiador para conectores 2,5 mm. (para FC, SC y ST)	17069	1
			Limpiador para conectores 1,25 mm. (para LC, MU)	17070	1
			Cassette limpiador conectores FO	17072	1
Herramientas de Instalación de Fibra Óptica		Ref.	U/Emb.		
Ref. 14005			Tijera especial corte Kevlar	14006	1
Ref. 14006			Peladora 125/250/900 µm para fibra óptica	14005	1
			Herramienta crimpar conectores RG58/59/62/Fibra	40067	1
Ref. 40067			Peladora Miller Revestimiento	17013	1
			Sangradora cable Ideal	17015	1
			Herramienta de sangrado cables fibra	14007	1
			Herramienta de empalme mecánico fibra	14008	1

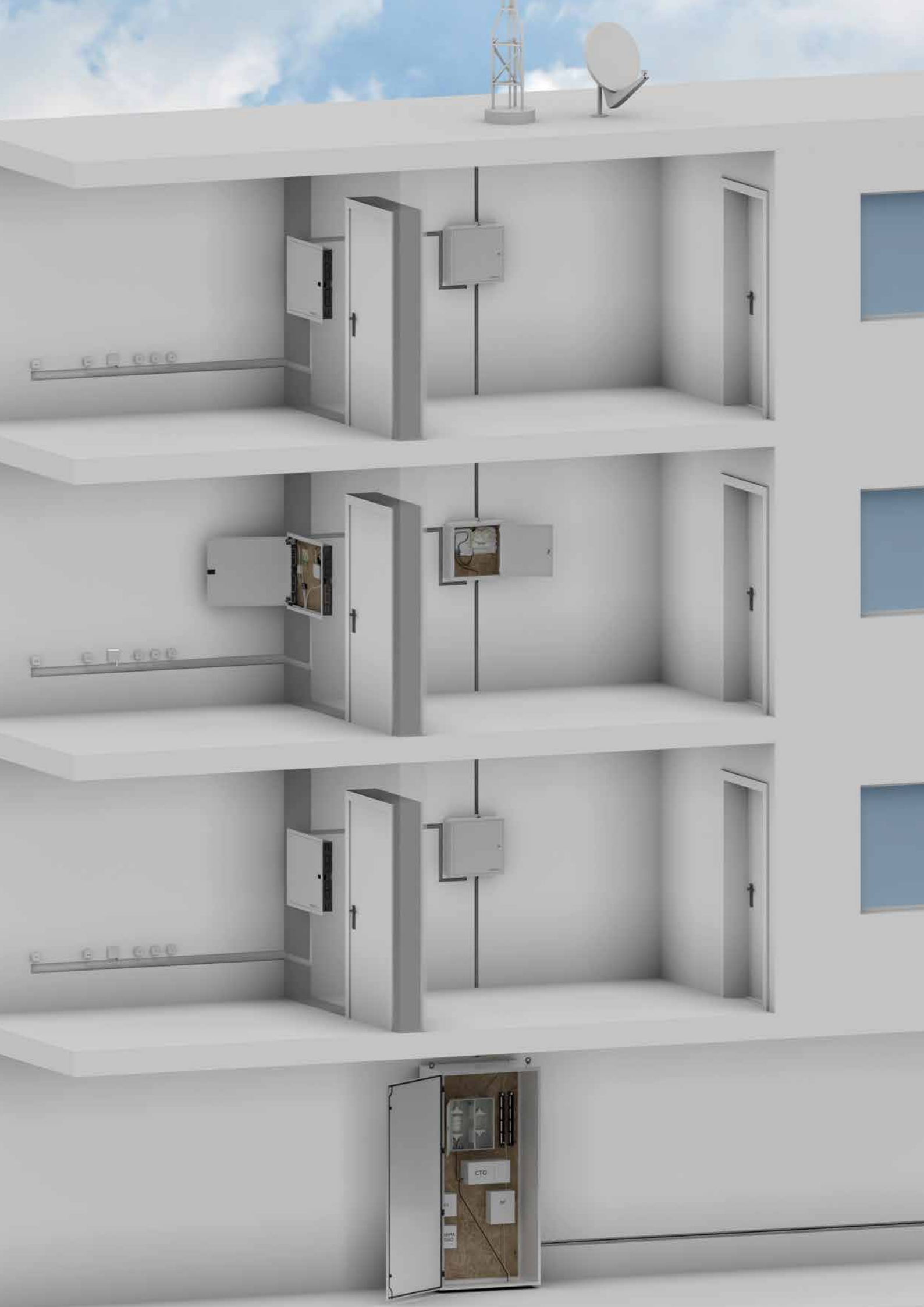



ICT-2

Infraestructura Común de Telecomunicaciones

Planta interna: fibra óptica y cobre 42

Planta externa 50

Equipos de medición ICT-2 (*ver sección Fibra Óptica)

* Reflectómetros ópticos OTDR 36

* Medidores de fibra óptica y de ICT-2 37

* Herramientas de fusión e instalación 38

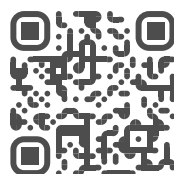

Configura tu proyecto de planta interna (ICT-2) en tres simples pasos con myNET

mynet.openetics.com



CABLE FIBRA ÓPTICA MONOMODO FTTH

Cable Fibra Óptica Multitubo Armado Dieléctrico Dca 9/125 μm Estructura Holgada	Ref.	U/Emb.
Cable fibra óptica multitubo armado dieléctrico Dca, s2, d2, a1 9/125 μm 24 fibras cubierta color marfil G-657A2	49820	1
Cable fibra óptica multitubo armado dieléctrico Dca, s2, d2, a1 9/125 μm 36 fibras cubierta color marfil G-657A2	49821	1
Cable fibra óptica multitubo armado dieléctrico Dca, s2, d2, a1 9/125 μm 48 fibras cubierta color marfil G-657A2	49822	1

Ref. 49820



Cable Fibra Óptica Armado Dieléctrico 9/125 μm Dca Recubrimiento Ajustado	Ref.	U/Emb.
Cable fibra óptica armado dieléctrico 9/125 μm 2 fibras ajustada cubierta color marfil Dca, s2, d2, a1 G-657A2 (bobina 500 m)	49823	1

Ref. 49823

**CABLES MONOMODO BIFIBRA CONECTARIZADO 1 EXTREMO**

Cable Monomodo OS2 [9/125 μm] Dca	Ref.	U/Emb.
Cable monomodo bifibra SC/APC conectorizado 1 extremo de 10 m Dca s1a,d0,a1 G-657A2	50750	1
Cable monomodo bifibra SC/APC conectorizado 1 extremo de 15 m Dca s1a,d0,a1 G-657A2	50751	1
Cable monomodo bifibra SC/APC conectorizado 1 extremo de 20 m Dca s1a,d0,a1 G-657A2	50752	1
Cable monomodo bifibra SC/APC conectorizado 1 extremo de 25 m Dca s1a,d0,a1 G-657A2	50753	1
Cable monomodo bifibra SC/APC conectorizado 1 extremo de 40 m Dca s1a,d0,a1 G-657A2	50754	1
Cable monomodo bifibra SC/APC conectorizado 1 extremo de 50 m Dca s1a,d0,a1 G-657A2	50755	1

Ref. 50753



LATIGUILLOS MONOMODO BIFIBRA CONECTORIZADO 2 EXTREMOS

Ref. 50741



Latiguillo Monomodo OS2 [9/125 μm] Dca	Ref.	U/Emb.
Latiguillo monomodo SC/APC de 20 m Dca s1,d1,a1 G-657A2 bifibra	50740	1
Latiguillo monomodo SC/APC de 30 m Dca s1,d1,a1 G-657A2 bifibra	50741	1
Latiguillo monomodo SC/APC de 40 m Dca s1,d1,a1 G-657A2 bifibra	50742	1
Latiguillo monomodo SC/APC de 50 m Dca s1a,d0,a1 G-657A2 bifibra	50743	1
Latiguillo monomodo SC/APC de 80 m Dca s1a,d0,a1 G-657A2 bifibra	50744	1
Latiguillo monomodo SC/APC de 100 m Dca s1a,d0,a1 G-657A2 bifibra	50745	1

Ref. 50506

**PASAMUROS PARA FIBRA ÓPTICA MONOMODO**

Pasamuros Monomodo	Ref.	U/Emb.
Pasamuros monomodo SC/SC pulido APC simple	50506	1
Pasamuro monomodo SC/SC pulido APC simple con tapa	50513	1

EMPALMES MECÁNICOS

Ref. 50481



Empalme Mecánico	Ref.	U/Emb.
Empalme mecánico para fibra óptica (250 μm y 900 μm)	50480	1
Empalme mecánico para cassette fibra óptica (250 μm y 900 μm)	50481	20

Ref. 50576

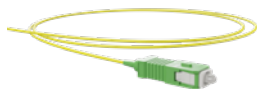
**PIGTAILS MONOMODO MONOFIBRA 0,9 MM**

Pigtail Monomodo OS2 [9/125 μm] Dca Pulido APC	Ref.	U/Emb.
Pigtail monomodo SC/APC de 1 m Dca s1,d1,a1 G-657A2 0,9 mm	50576	1

ENVOLVENTES DE FIBRA ÓPTICA

Ref. 50452

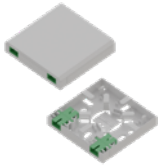

Rosetas Terminales de Fibra Óptica	Ref.	U/Emb.
Roseta 2 fibras para pasamuros SC/SC N1	50452	1
Roseta 4 fibras para pasamuros SC/SC B	50454	1
Roseta 2 fibras para pasamuros SC/SC N2	50453	1

Ref. 51225



Caja Mural Estanca PVC	Ref.	U/Emb.
Caja mural estanca 4 fibras para conectores SC y LC duplex	50455	1
Caja mural estanca 8 fibras para conectores SC y LC duplex	51225	1
Caja mural estanca 16 fibras para conectores SC y LC duplex	51226	1

Ref. 51232



Caja Mural Metálica	Ref.	U/Emb.
Caja mural 24 fibras para conectores SC	51230	1
Caja mural 48 fibras para conectores SC	51231	1
Caja mural 72 fibras para conectores SC	51232	1
Caja mural metálica SLIM 24 fibras para conectores SC y LC duplex	50068	1
Caja mural metálica SLIM 24 fibras para conectores ST	50069	1
Caja mural metálica SLIM 12 fibras para conectores SC y ST duplex	50070	1

Las cajas murales metálicas no incluyen pasamuros.

Ref. 50068



Ref. 5114



Protector Termo Retráctil	Ref.	U/Emb.
Protector termo retráctil 40 mm	5114	1
Protector termo retráctil 45 mm	5115	1
Protector termo retráctil 60 mm	5116	1

Ref. 07670



Cajas de Registro Principal y Secundario	Ref.	U/Emb.
Registro secundario 45x45x15 cm	07670	1
Registro principal 70x50x15 cm	07672	1

Ref. 7669



Cajas de Registro RTR	Ref.	U/Emb.
Registro RTR 600x500x80 mm*	7669	1
* Accesorio registro RTR (Ref. 7669): PDU regleta eléctrica 2 tomas	26005	1

Ref. 7634



Armarios RITI	Ref.	U/Emb.
Armario RITI 2000x1000x500 mm	7634	1
Armario RITI 2000x1500x500 mm	7635	1

PACKS ROSETAS FIBRA ÓPTICA ICT-2

Packs Rosetas Fibra Óptica ICT-2 Bifibra Conectados por un Extremo SC/APC	Ref.	U/Emb.
Pack roseta fibra óptica + latiguillo bifibra conectados por un extremo 10 m ICT-2	50530	1
Pack roseta fibra óptica + latiguillo bifibra conectados por un extremo 15 m ICT-2	50531	1
Pack roseta fibra óptica + latiguillo bifibra conectados por un extremo 20 m ICT-2	50532	1
Pack roseta fibra óptica + latiguillo bifibra conectados por un extremo 25 m ICT-2	50533	1
Pack roseta fibra óptica + latiguillo bifibra conectados por un extremo 40 m ICT-2	50534	1
Pack roseta fibra óptica + latiguillo bifibra conectados por un extremo 50 m ICT-2	50535	1
Pack roseta fibra óptica + latiguillo bifibra conectados por un extremo 70 m ICT-2	50536	1
Pack roseta fibra óptica + latiguillo bifibra conectados por un extremo 80 m ICT-2	50537	1
Pack roseta fibra óptica + latiguillo bifibra conectados por un extremo 100 m ICT-2	50538	1

Ref. 50531

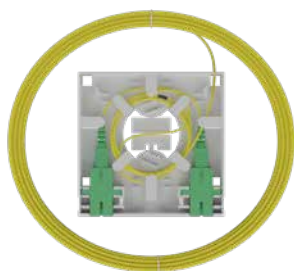

Packs Rosetas Fibra Óptica ICT-2 Monofibra Conectados por un Extremo SC/APC	Ref.	U/Emb.
Pack roseta fibra óptica + latiguillo monofibra conectados por un extremo 10 m ICT-2	50539	1
Pack roseta fibra óptica + latiguillo monofibra conectados por un extremo 15 m ICT-2	50540	1
Pack roseta fibra óptica + latiguillo monofibra conectados por un extremo 20 m ICT-2	50541	1
Pack roseta fibra óptica + latiguillo monofibra conectados por un extremo 25 m ICT-2	50542	1
Pack roseta fibra óptica + latiguillo monofibra conectados por un extremo 40 m ICT-2	50543	1
Pack roseta fibra óptica + latiguillo monofibra conectados por un extremo 50 m ICT-2	50544	1
Pack roseta fibra óptica + latiguillo monofibra conectados por un extremo 70 m ICT-2	50545	1
Pack roseta fibra óptica + latiguillo monofibra conectados por un extremo 80 m ICT-2	50546	1
Pack roseta fibra óptica + latiguillo monofibra conectados por un extremo 100 m ICT-2	50547	1

Ref. 50540

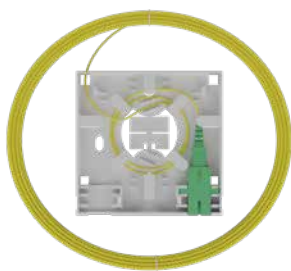

SERVICIOS COMUNES PARA RITI

Ref. 51230



Ref. 53200



Ref. 50590

Servicios comunes	Ref.	U/Emb.
Servicios comunes hasta 10 viviendas con panel acometida Ref. 50072	50548	1
Servicios comunes hasta 10 viviendas con rack 19" Ref. 23200	50549	1
Servicios comunes hasta 10 viviendas con caja mural fibra óptica Ref. 51230	50552	1
Servicios comunes de 11 a 20 viviendas con rack 19" Ref. 23200	50553	1
Servicios comunes de 11 a 20 viviendas con caja mural fibra óptica Ref. 51231	50554	1
Servicios comunes de 21 a 32 viviendas con rack 19" Ref. 23200	50555	1
Servicios comunes de 21 a 32 viviendas con caja mural fibra óptica Ref. 51232	50556	1
Servicios comunes de 33 a 40 viviendas con rack 19" Ref. 23200	50557	1
Caja mural estanca 16 fibras para conectores SC y LC Duplex	51226	1
Pack por Vivienda	Ref.	U/Emb.
Pack PAU por vivienda	50590	1

CABLES CAT. 6

CPR

Ref. 0706D2

Cable Cat. 6 U/UTP con Cruceta Separadora	Ref.	U/Emb.
Cable Cat. 6 U/UTP rígido Lszh Dca s2,d2,a1 en cajas de 305 m	0706D2	305 m
Cable Cat. 6 U/UTP rígido Lszh Dca s2,d2,a1 en bobinas de 500 m	0702D2	500 m
Cable Cat. 6 U/UTP rígido Lszh Dca s2,d2,a1 en bobinas de 1.000 m	0703D2	1000 m

LATIGUILLOS CAT. 6 U/UTP LSZH

Ref. 6700

Latiguillos Cat. 6 U/UTP LSZH	Ref.	U/Emb.
Latiguillo Cat. 6 U/UTP LSZH 0,5 m	6700	1
Latiguillo Cat. 6 U/UTP LSZH 1 m	6701	1
Latiguillo Cat. 6 U/UTP LSZH 2 m	6822	1
Latiguillo Cat. 6 U/UTP LSZH 3 m	6823	1
Latiguillo Cat. 6 U/UTP LSZH 5 m	6825	1
Latiguillo Cat. 6 U/UTP LSZH 10 m	6830	1

Otras longitudes y colores, consultar



Ref. 50072

PANELES ACOMETIDA ICT

Panel Acometida ICT	Ref.	U/Emb.
Panel acometida ICT completo para 12 salidas (12 SC/APC + 12 RJ45)	50071	1
Panel acometida ICT completo para 24 salidas (24 SC/APC + 24 RJ45)	50072	1

PANELES DE PARCHEO CAT. 6



Ref. 05617

Panel Cat. 6 UTP GIGALAN 350+	Ref.	U/Emb.
Patch panel 1 U 24 puertos Cat. 6 UTP, modelo Gigalan 350	05617	1
Patch panel 12 puertos Cat. 6 UTP	5615	1

CONECTORES CAT. 6



Ref. 0020

Conectores Cat. 6 Macho	Ref.	U/Emb.
Conector RJ45 Cat. 6 UTP macho para cable flexible	0020	100



Cubre Conectores Cat. 6	Ref.	U/Emb.
■ Cubre conector RJ45 Cat. 6 gris	1210	100
■ Cubre conector RJ45 Cat. 6 rojo	1224	100
■ Cubre conector RJ45 Cat. 6 azul	1225	100
■ Cubre conector RJ45 Cat. 6 verde	1226	100
■ Cubre conector RJ45 Cat. 6 amarillo	1227	100
■ Cubre conector RJ45 Cat. 6 negro	1229	100



Ref. 50523

MULTIPLEXORES PASIVOS

Multiplexores Pasivos	Ref.	U/Emb.
Multiplexor pasivo 1E/9S	50523	1

ROSETAS Y MÓDULOS PASIVOS



Ref. 12003

Ref. 12005

Roseta	Ref.	U/Emb.
Marco y bastidor blanco 45x45 mm	12005	1
Cajetín de superficie blanco 80x80 mm	12003	1



Ref. 12006

Ref. 12007

Módulos	Ref.	U/Emb.
Módulo blanco con ventana 45x45 mm para 1 keystone Cat. 5e/6/6A	12006	1
Módulo blanco con ventana 45x45 mm para 2 keystone Cat. 5e/6/6A	12007	1

Ref. 7652

**CAJAS DE CONEXIONES Y ACCESORIOS**

Cajas de Conexiones	Ref.	U/Emb.
Caja conexiones para 30 pares	7649	1
Caja conexiones para 50 pares	7651	1
Caja conexiones para 100 pares	7652	1

Ref. 7660



Regletas	Ref.	U/Emb.
Regleta 5 pares corte y prueba	7674	1
Regleta 10 pares corte y prueba	7660	1

Ref. 7662

Ref. 7661



Soporte para Regletas	Ref.	U/Emb.
Soporte para 1 regleta de 5 pares	7673	1
Soporte para 5 regletas de 5 pares	7675	1
Soporte para 5 regletas de 10 pares	7661	1
Soporte para 10 regletas de 10 pares	7662	1

Ref. 7665



Clavijas	Ref.	U/Emb.
Clavija de corte	7665	1

REGISTRO DE TERMINACION DE RED

Ref. 8011



Registro Terminación de Red	Ref.	U/Emb.
Registro de terminación de red PAU-PTR 1 línea	8010	1
Registro de terminación de red PAU-PTR 2 líneas	8011	1

CONECTORES

Ref. 1218

Ref. 1219

Ref. 1219/E



Conectores Macho	Ref.	U/Emb.
Conector macho RJ12 6P/6C	1218	100
Conector macho RJ11 4P/4C	1219/E	100
Conector macho RJ11 6P/4C	1219	100

Ref. 4617



Conector UY2	Ref.	U/Emb.
Conector UY2	4617	100

CABLES COAXIALES

Ref. 7606

Ref. 0309

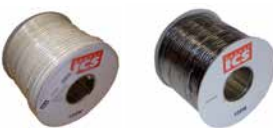

Cable Coaxial	Ref.	U/Emb.
Cable coaxial RG-59 mil C-17 75 ohm, rollo 100 m	0309	100 m
Cable coaxial FI (RTV-SAT) cobre, rollo 100 m	7606	100 m
Cable coaxial FI (RTV-SAT) aluminio, rollo 100 m	7607	100 m

SOLUCIÓN
MACH3



HERRAMIENTA
110

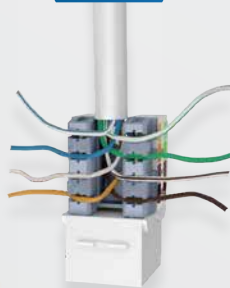

Con la Solución Mach3 "AHORRARÁS" tiempo, esfuerzo y dinero

Diferencias del conexionado:



Salida del cable orientable a 90°, 180° y 270°. Diseñado para espacios reducidos.

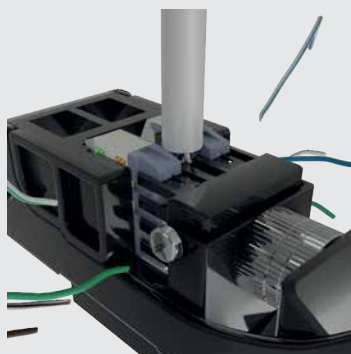

Conecta los 8 conductores a la vez y corta el sobrante del cable con la herramienta Mach3.



Utiliza la crimpadora Mach3 para una mayor rapidez y seguridad de conexión.

CPR

Ref. 14954



CABLE FIBRA MONOMODO ICT-2

Cables Fibra Óptica Monotubo Armado Metálico Exterior 9/125 μm Estructura Holgada	Ref.	U/Emb.
---	------	--------

¡Nuevo! Cable fibra óptica armado metálico exterior Fca 9/125 μm
16 fibras

14954

1

¡Nuevo! Cable fibra óptica armado metálico exterior Fca 9/125 μm
24 fibras

14955

1

Cables Fibra Óptica Multitubo Armado Metálico Exterior 9/125 μm Estructura Holgada	Ref.	U/Emb.
--	------	--------

Cables fibra óptica multitubo armado metálico exterior 9/125 μm
32 fibras

49500

1

Cables fibra óptica multitubo armado metálico exterior 9/125 μm
48 fibras

49501

1

Cables fibra óptica multitubo armado metálico exterior 9/125 μm
64 fibras

49502

1

Cables fibra óptica multitubo armado metálico exterior 9/125 μm
72 fibras

49503

1

Cables fibra óptica multitubo armado metálico exterior 9/125 μm
96 fibras

49504

1

Cables fibra óptica multitubo armado metálico exterior 9/125 μm
128 fibras

49505

1

Cables fibra óptica multitubo armado metálico exterior 9/125 μm
144 fibras

49506

1



CAJAS DE EMPALME Y TORPEDOS ESTANCOS

Caja de Empalme Estanca para Fibra Óptica	Ref.	U/Emb.
---	------	--------

Ref. 51205



Caja de empalme estanca para fibra óptica hasta 24 fibras 3E

51223

1

Caja de empalme estanca para fibra óptica hasta 24 fibras 2E/2S

51205

1

Caja de empalme estanca para fibra óptica hasta 48 fibras 1E/1S

51201

1

Caja de empalme estanca para fibra óptica hasta 96 fibras 4E/4S

51203

1

Torpedo de Fibra Óptica Estanco Tipo Botella	Ref.	U/Emb.
--	------	--------

Ref. 51248



Torpedo estanco de fibra óptica 96 fibras 2E/2S o 3E/3S

51248

1

Torpedo estanco de fibra óptica 256 fibras 4E/4S

51250

1

Torpedo de Fibra Óptica Estanco Tipo Botella en Línea	Ref.	U/Emb.
---	------	--------

Torpedo estanco de fibra óptica 147 fibras 3E/3S

51249

1

Ref. 5195



Accesorios Torpedos Fibra Óptica	Ref.	U/Emb.
Cassette de empalme para 12 fusiones	5195	1
Cassette de empalme para 24 fusiones	5194	1
Protector termo retráctil 40 mm	5114	1
Protector termo retráctil 45 mm	5115	1
Protector termo retráctil 60 mm	5116	1

SPLITTER



Splitter	Ref.	U/Emb.
Splitter 1x2 conector SC/APC	50620	1
Splitter 1x4 conector SC/APC	50621	1
Splitter 2x4 conector SC/APC	50625	1
Splitter 1x8 conector SC/APC	50622	1
Splitter 2x8 conector SC/APC	50626	1
Splitter 1x16 conector SC/APC	50623	1
Splitter 2x16 conector SC/APC	50627	1
Splitter 1x32 conector SC/APC	50624	1
Splitter 2x32 conector SC/APC	50628	1

Ref. 51206



ARMARIO DISTRIBUIDOR DE FIBRA ÓPTICA

Armario Distribuidor de Fibra Óptica	Ref.	U/Emb.
Armario de interconexión de fibra capacidad 288 fibras 1450x750x360 mm	51206	1

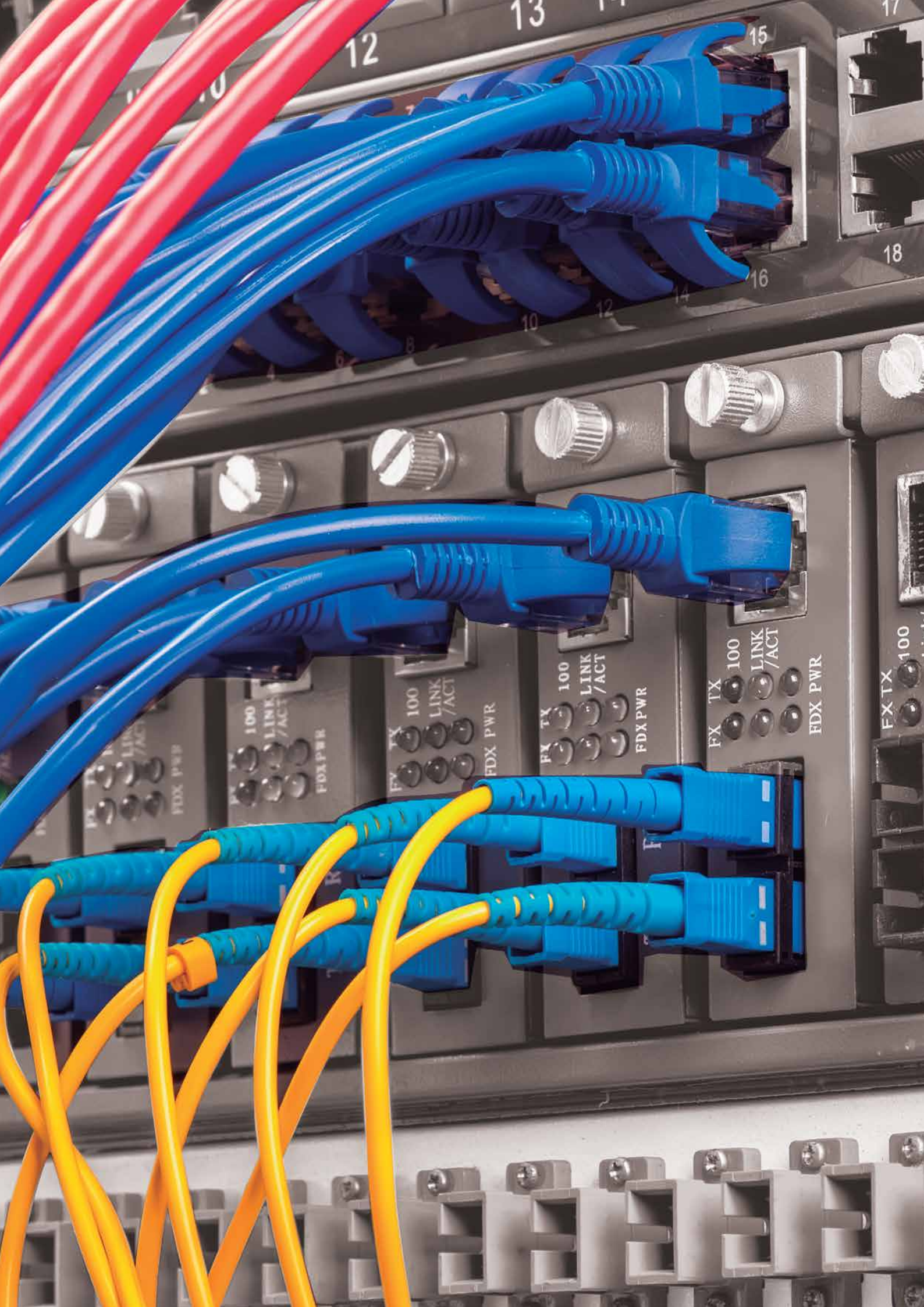



Electrónica de Red

Switches Fast Ethernet	54
Switches Gigabit	54
Convertidores de fibra óptica	54
Módulos SFP de uso comercial	55
Módulos SFP de uso industrial	57

SWITCH FAST ETHERNET > NO GESTIONABLE

Ref. 21253



Switch Fast Ethernet > No Gestionable	Ref.	U/Emb.
Switch 8 puertos 10/100 Mbps sobremesa	21253	1
Switch PoE 6 puertos RJ45 10/100 Base T (4 PoE + 2 Uplink)	21507	1
Switch PoE 9 puertos RJ45 10/100 Base T (8 PoE + Uplink)	21505	1

SWITCH FAST ETHERNET > GESTIÓN WEB L2

Ref. 21261



Switch Fast Ethernet > Gestión Web L2	Ref.	U/Emb.
Switch 24 puertos 10/100 Mbps + 2 puertos Gigabit + 2 slots SFP (montable en Rack 19")	21261	1

Módulos Gigabit Ethernet SFP (1.25Gb/s) para Ref. 21261	Ref.	U/Emb.
SFP, 1000 BASE-SX, LC, dual fiber 850 nm; 550 m on 50 µm MM, 220 m on standard 62,5 µm MM, 0 to 70°C	2187	1
SFP, 1000 BASE-LX/LH, LC, dual fiber 1310 nm; 20 km on standard SM, 550 m on any MM, 0 to 70°C	2186	1

Ref. 2187

**SWITCH GIGABIT > NO GESTIONABLE**

Ref. 21242



Switch Gigabit > No Gestionable	Ref.	U/Emb.
Switch 8 puertos 10/100/1000 Mbps	21321	1
Switch 24 puertos 10/100/1000 Mbps (montable en Rack 19")	21242	1
Switch 24 puertos 10/100/1000 Mbps + 2 slots SFP	21300	1

CONVERTIDORES DE FIBRA ÓPTICA

Ref. 21410



Convertidores	Ref.	U/Emb.
Convertidor de medio Fast Ethernet [10/100BTX-100BFX] [multimodo duplex SC]	21410	1
Convertidor de Medio Fast Ethernet [10/100BTX-100BFX] [monomodo duplex SC]	21413	1
Convertidor de medio Gigabit Ethernet [10/100/1000 Base-TX a 1000 Base-SX] [multimodo duplex SC]	21430	1
Convertidor de medio Gigabit Ethernet [10/100/1000 Base-TX a 1000 Base-SX] [monomodo duplex SC]	21433	1
Chasis 19" 2 U 14 slot para convertidor de medio	21450	1

Ref. 21433



Fuente de alimentación incluida.

MÓDULOS SFP DE USO COMERCIAL (0 A 70°C)

Fast Ethernet SFP (155 Mb/s)	Ref.	U/Emb.
100Mbps RJ45 SFP, 100 BASE-T standard 100 m	21270	1
SFP, 100 BASE-FX, LC, dual fiber 1310 nm, 2 km on MM, 0 to 70°C	21271	1
SFP, 100 BASE-FX, LC, dual fiber 1310 nm, 20 km on standard SM, 0 to 70°C	21272	1
SFP, 100 BASE-FX, LC, dual fiber 1310 nm, 40 km on standard SM, 0 to 70°C	21273	1
SFP, 100 BASE-FX, LC, dual fiber 1550 nm, 80 km on standard SM, 0 to 70°C	21274	1
SFP bi-directional transceiver, 1310 nm/1550 nm, LC, 20 km, with digital diagnostic monitoring, 0 to 70°C	21278	Par
SFP bi-directional transceiver, 1550 nm/1310 nm, LC, 40 km, with digital diagnostic monitoring, 0 to 70°C	21281	Par
SFP bi-directional transceiver, 1550 nm/1310 nm, LC, 80 km, with digital diagnostic monitoring, 0 to 70°C	21284	Par
Gigabit Ethernet SFP (1.25 Gb/s)	Ref.	U/Emb.
1000Mbps RJ45 SFP with spring latch, 1000 BASE-T standard, 100 m	21290	1
SFP, 1000 BASE-SX, LC, dual fiber 850 nm, 550 m on standard 50 µm MM, 220 m on standard 62,5 µm MM, 0 to 70°C	2187	1
SFP, 1000 BASE-LX/LH, LC, dual fiber 1310 nm, 20 km on standard SM, 550 m on any MM, 0 to 70°C	2186	1
SFP, 1550 nm DFB, LC, SM 40 km, with digital diagnostic monitoring, 0 to 70°C	21291	1
SFP, 1550 nm DFB, LC, SM 80 km, with digital diagnostic monitoring, 0 to 70°C	21292	1
SFP bi-directional transceiver, 1310 nm/1550 nm, LC, SM 20 km, with digital diagnostic monitoring, 0 to 70°C	21202	Par
SFP bi-directional transceiver, 1310 nm/1550 nm, LC, SM 40 km, with digital diagnostic monitoring, 0 to 70°C	21205	Par
SFP bi-directional transceiver, 1490 nm TX/1550 nm RX, LC, SM 80 km, with digital diagnostic monitoring, 0 to 70°C	21208	Par
SFP bi-directional transceiver, 1490nm / 1550nm, LC, SM 120 km, with digital diagnostic monitoring, 0 to 70°C	21211	Par

Ref. 21270



Ref. 21271



Ref. 21290



MÓDULOS SFP DE USO COMERCIAL (0 a 70°C)

Ref. 21215



10 Gigabit Ethernet SFP+	Ref.	U/Emb.
SFP+, 10GBASE-SR, LC, 850 nm, 300 m on multimode fiber (MM OM3), with digital diagnostic monitoring, 0 to 70°C	21215	1
SFP+, 10GBASE-LR, LC, 1310 nm, 10 km on SM fiber, with digital diagnostic monitoring, 0 to 70°C	21216	1

Ref. 21218



10 Gigabit XFP	Ref.	U/Emb.
10GBASE-SR XFP transceiver module for MM, 850 nm, 300 m, dual LC connector, with digital diagnostic monitoring, 0 to 70°C	21218	1
10GBASE-LR XFP transceiver module for SM, 1310 nm, 10 km, dual LC connector, with digital diagnostic monitoring, 0 to 70°C	21219	1

Ref. 21221



10 Gigabit X2	Ref.	U/Emb.
X2, 10GBASE-SR, SC, 850 nm, 300 m on multimode fiber (MM OM3), with digital diagnostic monitoring, 0 to 70°C	21221	1
X2, 10GBASE-LR, SC, 1310 nm, 10 km on SM fiber, with digital diagnostic Monitoring, 0 to 70°C	21222	1

10 Gigabit XENPAK	Ref.	U/Emb.
XENPAK, 10GBASE-SR, SC, 850 nm, 300 m on multimode fiber (MM OM3), with digital diagnostic monitoring, 0 to 70°C	21224	1
XENPAK, 10GBASE-LR, SC, 1310 nm, 10 km on SM fiber, with digital diagnostic monitoring, 0 to 70°C	21225	1

Ref. 21227



40G QSFP+	Ref.	U/Emb.
40GBASE-SR4, 4-Channel, 850 nm, 100 m on OM3 MM fiber or 150 m on OM4 MM fiber, 0 to 70°C	21227	1
40GBASE-LR4, 4 CWDM lanes, 1310 nm, 10 km on SM, 0 to 70°C	21228	1

MÓDULOS SFP DE USO INDUSTRIAL (- 40 A 85°C)

Ref. 21875



Fast Ethernet SFP (155 Mb/s)	Ref.	U/Emb.
SFP, 100BASE-FX, LC, dual fiber 1310 nm, 2 km on standard MM, -40 to 85°C	21875	1
SFP, 100BASE-FX, LC, dual fiber 1310 nm, 20 km on standard SM, -40 to 85°C	21876	1
SFP, 100BASE-FX, LC, dual fiber 1310 nm, 40 km on standard SM, -40 to 85°C	21879	1
SFP, 100BASE-FX, LC, dual fiber 1550 nm, 80 km on standard SM, -40 to 85°C	21880	1
SFP bi-directional transceiver, 1310 nm/1550 nm, LC, 20 km, with digital diagnostic monitoring, -40 to 85°C	21883	Par
SFP bi-directional transceiver, 1550 nm/1310 nm, LC, 40 km, with digital diagnostic monitoring, -40 to 85°C	21886	Par
SFP bi-directional transceiver, 1550 nm/1310 nm, LC, 80 km, with digital diagnostic monitoring, -40 to 85°C	21889	Par

Ref. 21877



Gigabit Ethernet SFP (1.25 Gb/s)	Ref.	U/Emb.
SFP, 1000 BASE-SX, LC, dual fiber 850 nm, 550 m on standard 50 µm MM, 220 m on standard 62,5 µm MM, -40 to 85°C	21877	1
SFP, 1000 BASE-LX/LH, LC, dual fiber 1310 nm, 20 km on standard SM, -40 to 85°C	21878	1
SFP, 1550 nm DFB, LC, 40 km, with digital diagnostic monitoring, -40 to 85°C	21902	1
SFP, 1550 nm DFB, LC, 80 km, with digital diagnostic monitoring, -40 to 85°C	21903	1
SFP bi-directional transceiver, 1310 nm/1550 nm, LC, 20 km, with digital diagnostic monitoring, -40 to 85°C	21906	Par
SFP bi-directional transceiver, 1310 nm/1550 nm, LC, 40 km, with digital diagnostic monitoring, -40 to 85°C	2182	Par
SFP bi-directional transceiver, 1310 nm/1490 nm, LC, 40 km, with digital diagnostic monitoring, -40 to 85°C	2181	Par
SFP bi-directional transceiver, 1490 nm/1550 nm, LC, 80 km, with digital diagnostic monitoring, -40 to 85°C	21915	Par
SFP bi-directional transceiver, 1490 nm/1550 nm, LC, 120 km, with digital diagnostic monitoring, -40 to 85°C	21918	Par



OPENETICS

OPENETICS

31
32
31
30
29
28
27
26
25
24
23
22
21
20
19
18
17
16
15
14
13
12
11
10
9



Armarios Rack 19"

Racks murales 19"	60
Racks de pie 19"	62
Racks de pie 19" para servidores	66
Racks de intemperie	68
Racks para baterías solares	70
Bandejas para racks	71
Accesorios para racks	72

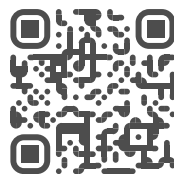

Configura tus armarios
rack 19" con el módulo
Campus de myNET

mynet.openetics.com



RACKS MURALES

Ref. 24025



Kit Mini Rack 10" [Negro RAL 9005]	Ref.	U/Emb.
Kit Mini Rack 10" 6 U 344x350x280 mm	24025	1

El Kit Mini Rack incluye: rack metálico 10" 6 U, panel vacío 16 puertos 10" 1,5 U y estante normalizado 10" 1 U.

Ref. 24080



Accesorios para Mini Rack 10" [Negro RAL 9005]	Ref.	U/Emb.
PDU regleta eléctrica 2 tomas 10"	26005	1

Ref. 24070



Panel vacío 16 puertos 10" 1,5 U	24070	1
----------------------------------	-------	---

Estante normalizado 10" 1 U	24080	1
-----------------------------	-------	---

Cierre de 1/4 de vuelta con combinación	27629	1
---	-------	---

RACKS PLANOS

Ref. 2415

Ref. 2413



Housing 19"	Ref.	U/Emb.
2 U alto 344x490x100 mm	2360	1
4 + 2 U alto 610x550x130 mm	2413	1
4 + 2 U alto 610x550x130 mm (puerta ciega)	2414	1
4 + 3 U alto 730x550x180 mm (puerta ciega)	2415	1
4 + 3 U alto 730x550x180 mm	2412	1

Accesorios para Housing 19"	Ref.	U/Emb.
Cierre de 1/4 de vuelta con combinación	27629	1
Kit carril DIN 24 polos	24210	1

Accesorio compatible con las refs. 2412 / 2413 / 2414 / 2415.

Ref. 2511



Flat Rack	Ref.	U/Emb.
Flat Rack 530x610x225 mm puerta transparente	2511	1

Ref. 23200



Ref. 23211



Ref. 23224



Ref. 23265



Ref. 23304



Ref. 27650



Ref. 23310



UNIRACKS (permite su instalación sobre pared o suelo)

UniRack 1 Cuerpo Fondo 400 / 500 / 600 Puerta de Cristal Templada [Negro RAL 9005]	Ref.	U/Emb.
6 U alto 310x540x400 mm	23200	1
9 U alto 445x540x400 mm	23201	1
12 U alto 580x540x400 mm	23202	1
6 U alto 310x540x500 mm	23210	1
9 U alto 445x540x500 mm	23211	1
12 U alto 580x540x500 mm	23212	1
15 U alto 710x540x500 mm	23213	1
9 U alto 445x540x600 mm	23231	1
12 U alto 580x540x600 mm	23232	1
15 U alto 710x540x600 mm	23233	1
20 U alto 933x540x600 mm	23224	1
25 U alto 1155x540x600 mm	23225	1

Se pueden suministrar insonorizados con la misma referencia terminada en "NR" (noise reduction).

UniRack 1 Cuerpo Fondo 500 / 600 Puerta Metálica Ciega [Negro RAL 9005]	Ref.	U/Emb.
6 U alto 310x540x500 mm	23240	1
9 U alto 445x540x500 mm	23241	1
12 U alto 580x540x500 mm	23242	1
15 U alto 710x540x500 mm	23243	1
20 U alto 933x540x600 mm	23264	1
25 U alto 1155x540x600 mm	23265	1

Accesorios UniRack	Ref.	U/Emb.
Juego de 4 pies regulables	23302	1
Portaplanos autoadhesivo	27650	1
Cierre de 1/4 de vuelta con combinación	27629	1
Set de 4 ruedas para UniRack	23301	1
Panel de ventilación Silent 190 m ³ /h para UniRack	23304	1
Panel de ventilación Silent 190 m ³ /h con termostato para UniRack	23311	1
Cerradura electrónica para rack 19"	23310	1

racks 19"

SMART RACK PLUS CON PUERTA TRANSPARENTE

20 U

27 U

33 U

42 U

47 U

Smart Rack Plus [Color Negro RAL 9005]	Ref.	U/Emb.
20 U alto 1100x600x800 mm	2796	1
27 U alto 1300x600x600 mm	2799	1
27 U alto 1300x600x800 mm	2800	1
27 U alto 1300x800x800 mm	2804	1
27 U alto 1300x600x1000 mm	2806	1
33 U alto 1600x600x600 mm	2807	1
33 U alto 1600x600x800 mm	2808	1
33 U alto 1600x800x800 mm	2810	1
33 U alto 1600x600x1000 mm	2811	1
42 U alto 2000x600x600 mm	2812	1
42 U alto 2000x600x800 mm	2813	1
42 U alto 2000x600x1000 mm	2797	1
47 U alto 2200x600x600 mm	2817	1
47 U alto 2200x600x800 mm	2818	1
47 U alto 2200x800x800 mm	2820	1
47 U alto 2200x800x1000 mm	2798	1

Se pueden suministrar insonorizados con la misma referencia terminada en "NR" (noise reduction).

Ref. 2812

Ref. 2812



SMART RACK PLUS CON PUERTA VENTILADA

22 U

27 U

33 U

42 U

47 U

Smart Rack Plus [Color Negro RAL 9005]	Ref.	U/Emb.
22 U alto 1093x600x960 mm (puerta ventilada simple delantera y puerta ventilada doble trasera)	27109	1
27 U alto 1300x600x600 mm	2821	1
27 U alto 1300x600x800 mm	2822	1
27 U alto 1300x800x800 mm	2824	1
27 U alto 1300x600x1000 mm	2825	1
33 U alto 1600x600x600 mm	2826	1
33 U alto 1600x600x800 mm	2827	1
33 U alto 1600x800x800 mm	2829	1
33 U alto 1600x600x1000 mm	2830	1
42 U alto 2000x600x600 mm	2831	1
42 U alto 2000x600x800 mm	2832	1
42 U alto 2000x600x1000 mm	2844	1
47 U alto 2200x600x600 mm	2836	1
47 U alto 2200x600x800 mm	2837	1
47 U alto 2200x800x800 mm	2839	1
47 U alto 2200x800x1000 mm	2840	1

Se pueden suministrar insonorizados con la misma ref. terminada en 'NR' (noise reduction).

Ref. 2831

Ref. 2831



Ref. 02430



Ref. 27650



Ref. 23310



Ref. 2637



Ref. 2894



Ref. 23307



ACCESORIOS PARA SMART RACK PLUS

Accesorios para Smart Rack Plus	Ref.	U/Emb.
Pack 4 liras guía cables universal	5528	1
Tapa ciega 450x220 mm	2543	1
Portaplanos autoadhesivo	27650	1
Conjunto de montaje en batería	2559	1
¡Nuevo! Kit 4 ruedas con freno para Smart Rack Plus y Smart Rack Pack	02430	1
Cierre de 1/4 de vuelta con combinación para puerta ciega	27629	1
Cerradura electrónica para rack 19"	23310	1
Zócalo 100 mm 600x600 mm para Smart Rack Plus	2631	1
Zócalo 100 mm 600x800/800x600 mm para Smart Rack Plus	2629	1
Zócalo 100 mm 800x800 mm para Smart Rack Plus	2630	1
Zócalo 100 mm 600x1000 mm para Smart Rack Plus	2637	1
Zócalo 100 mm 800x1000 mm para Smart Rack Plus	2639	1
Conjunto 2 guía cables verticales traseros para rack 27 U 800 mm ancho	2895	1
Conjunto 2 guía cables verticales traseros para rack 33 U 800 mm ancho	2894	1
Conjunto 2 guía cables verticales traseros para rack 42 U 800 mm ancho	2893	1
Conjunto 2 guía cables verticales traseros para rack 47 U 800 mm ancho	2892	1
Panel ventilación Silent 300 m ³ /h para Smart Rack Plus	23306	1
Panel ventilación Silent 300 m ³ /h con termostato para Smart Rack Plus	23307	1

RACKS INSONORIZADOS

Net Acoustic Rack	Ref.	U/Emb.
Net Acoustic Rack 14 U 700x600x800	27900	1
Net Acoustic Rack 30 U 1400x600x800	27901	1
¡Nuevo! Net Acoustic Rack 30 U 1400x600x1000	27903	1
Net Acoustic Rack 42 U 2100x600x800	27902	1

Opcional en ancho de 750 mm, con puertas de doble hoja.

Opcional en fondo de 1200 mm.

Otros colores de la puerta delantera, bajo demanda.



Ref. 27900

Ref. 27901

Ref. 27902

Accesorios Net Acoustic Rack	Ref.	U/Emb.
Suplemento puerta frontal 14 U color especial	27910	1
Suplemento puerta frontal 30 U color especial	27911	1
Suplemento puerta frontal 42 U color especial	27912	1
Juego ruedas alta carga, con freno	27915	1
Zócalo para Net Acoustic Rack	27913	1
Módulo iluminación interior	27916	1

Ref. 27650

Ref. 23310



Accesorios Comunes para Rack 19"	Ref.	U/Emb.
Portaplanos autoadhesivo	27650	1
Cerradura electrónica para rack 19"	23310	1

42 U

[ancho 600 mm]

42 U

[ancho 750 mm]

48 U

[ancho 600 mm]

RACKS PARA SERVIDORES

PREMIUM Server Rack y Puertas	Ref.	U/Emb.
42 U 2000x600x1070 mm (sin puertas)	2622	1
42 U 2000x600x1200 mm (sin puertas)	26220	1
Puerta ventilada para Ref. 2622 / 26220	2623	1
Puerta doble ventilada para Ref. 2622 / 26220	2624	1
42 U 2000x750x1070 mm (sin puertas)	2620	1
42 U 2000x750x1200 mm (sin puertas)	26200	1
Puerta ventilada para Ref. 2620 / 26200	2618	1
Puerta doble ventilada para Ref. 2620 / 26200	2619	1
48 U 2260x600x1070 mm (sin puertas)	2621	1
48 U 2260x600x1200 mm (sin puertas)	26210	1
Puerta ventilada para Ref. 2621 / 26210	2625	1
Puerta doble ventilada para Ref. 2621 / 26210	2626	1

Ref. 2620 (con puertas 26220 + 26200)

Ref. 26200 (con puertas 26220 + 26200)



ACCESORIOS PARA PREMIUM SERVER RACK

Accesorios para PREMIUM Server Rack	Ref.	U/Emb.
Pack 4 liras guía cables universal	5528	1
Tapa ciega 450x220 mm	2543	1
Portaplanos autoadhesivo	27650	1
Soporte antivuelco server rack	2540	1
Maneta con combinación para puerta delantera y trasera	27616	1
Termómetro para puerta rack	2900	1
Panel ventilación 300 m ³ /h con termostato (admite hasta 2 unidades)	2542	1
Cerradura electrónica para rack 19"	23310	1

Ref. 2900



Ref. 27650

Ref. 23310



SMART RACK PACK [COLOR NEGRO RAL 9004]

Ref. 28105



Smart Rack Pack Fondo 800 [Color Negro RAL 9004]	Ref.	U/Emb.
42 U alto 2000x800x800 mm puerta transparente y ranurada	02815	1
42 U alto 2000x800x800 mm puerta ventilada	02834	1
42 U alto 2000x800x800 mm puerta delantera de doble hoja transparente + ranurada, puerta trasera de doble hoja ventilada.	28105	1

El pack incluye: kit de 4 ruedas con freno (Ref. 02430), panel de ventilación 800x800 mm con termostato (Ref. 02538) y juego de 4 pies regulables (Ref. 23315).

Se puede suministrar en 47 U de altura, bajo demanda.

Ref. 02430



Smart Rack Pack Fondo 1000 [Color Negro RAL 9004]	Ref.	U/Emb.
42 U alto 2000x800x1000 mm puerta transparente y ranurada	02816	1
42 U alto 2000x800x1000 mm puerta ventilada	02835	1
42 U alto 2000x800x1000 mm puerta delantera de doble hoja transparente + ranurada, puerta trasera de doble hoja ventilada	28106	1

El pack incluye: kit de 4 ruedas con freno (Ref. 02430), panel de ventilación 800x1000 mm con termostato (Ref. 02539) y juego de 4 pies regulables (Ref. 23315).

Se puede suministrar en 47 U de altura, bajo demanda.

Ref. 5528



Ref. 02538



Ref. 27649



Accesorios para Smart Rack Pack	Ref.	U/Emb.
Pack 4 liras guía cables universal	5528	1
Cierre de 1/4 de vuelta con combinación para puerta ciega	27629	1
Maneta con combinación para puerta delantera	27616	1
Zócalo 100 mm 800x800 mm para Smart Rack Pack	02630	1
Zócalo 100 mm 800x1000 mm para Smart Rack Pack	02639	1
Panel ventilación 800 x 800 mm para Smart Rack Pack	02541	1
Panel ventilación 800 x 800 mm para Smart Rack Pack con termostato	02538	1
Panel ventilación 800 x 1000 mm para Smart Rack Pack	02542	1
Panel ventilación 800 x 1000 mm para Smart Rack Pack con termostato	02539	1
Juego de 4 pies regulables	23315	1
¡Nuevo! Kit 4 ruedas con freno para Smart Rack Plus y Smart Rack Pack	02430	1
Conjunto 2 guía cables verticales traseros para 42 U	02893	1
Panel LED 19" 1U iluminación rack, 230 V	27649	1

RACKS DE INTEMPERIE

Ref. 26400



¡Nuevo! Rack Mural 1 Cuerpo IP55	Ref.	U/Emb.
Rack mural 1 cuerpo 6 U IP55 345x540x500 mm	26400	1
Rack mural 1 cuerpo 9 U IP55 480x540x500 mm	26401	1
Rack mural 1 cuerpo 12 U IP55 610x540x500 mm	26402	1
Rack mural 1 cuerpo 15 U IP55 750x540x500 mm	26403	1

Opcional en fondo 600 mm.

Ref. 23321



Armarios 19" Estancos IP66	Ref.	U/Emb.
Armario 19" estanco IP66, 12 U alto 600x600x400 mm	23320	1
Armario 19" estanco IP66, 16 U alto 800x600x400 mm	23321	1
Armario 19" estanco IP66, 20 U alto 1000x600x400 mm	23322	1
Armario 19" estanco IP66, 25 U alto 1200x600x400 mm	23323	1

*Incluye juego de perfiles 19" y tapa entrada cables.
Tejadillo vierteaguas y zócalo son opcionales.*

Ref. 23323



Accesorios para Armarios 19" Estancos IP66	Ref.	U/Emb.
Zócalo 100x600x400 mm para armarios 19" estancos IP66	23350	1
Zócalo 200x600x400 mm para armarios 19" estancos IP66	23351	1
Cerradura con llave 333 para armarios 19" estancos IP66	23353	1
Cerradura inoxidable para armarios 19" estancos IP66	23354	1
Cerradura inoxidable 3 puntos para armarios 19" estancos IP66	23355	1

Ref. 23325



Panel ventilación para armario 19" estanco IP66 (cumple la normativa IP 54)	23325	1
Juego soportes a pared para armarios 19" estancos IP66	23356	1
Pack sujeción a mástil para armarios de 300 hasta 800 mm anchura (2 uds.)	23331	2
Tejadillo vierteaguas para armarios 19" estancos IP66 (fondo 400)	23352	1

Ref. 27652



RACKS DE INTEMPERIE

Racks de Intemperie Serie Highway PLUS	Ref.	U/Emb.
¡Nuevo! Highway PLUS 19" 24 U 1200x600x600 mm	27652	1

*Consultar para modelos en acero inoxidable AISI 304L y 316L
Incluye: juego de perfiles 19", tejadillo vierteaguas y tapa entrada cables.*

Ref. 27653



Accesorios Opcionales para Highway PLUS 24 U	Ref.	U/Emb.
¡Nuevo! Zócalo 100 mm para Highway PLUS 600 mm	27654	1
¡Nuevo! Aislamiento térmico para Highway PLUS 24 U	27636	1
¡Nuevo! Panel ventilación con termostato para Highway PLUS 24 U	27653	1

Ref. 27637



Ventilación para Serie Highway PLUS 24 U	Ref.	U/Emb.
Panel ventilación con termostato para Highway PLUS	27634	1
Panel de ventilación redundante 76 m ³ /h con termostato	27637	1
Extractor lateral IP54 55 m ³ /h 230V 150x150 con filtro	27695	1
Extractor de techo IP54 630 m ³ /h 230V	27696	1
Rejilla IP54 150x150 con filtro	27697	1
Recambio filtro IP54 150x150	27698	1
Paravientos STORM IP65 para 150x150 (set 2 unidades)	27699	1
Termostato ventilación	2384	1

Ref. 27695



Ref. 27697



Calefacción para Serie Highway PLUS 24 U	Ref.	U/Emb.
Resistencia calefacción 45W 230V	27692	1
Resistencia calefacción 100W 230V	27693	1
Termostato calefacción	27694	1

Otras potencias o tensiones, consultar.

Ref. 27680



Ref. 27689



EQUIPOS DE CLIMATIZACIÓN

Climatización para serie Highway 24 U	Ref.	U/Emb.
Equipo climatización lateral 380W 230V	27680	1
Equipo climatización lateral 640W 230V	27681	1
Equipo climatización lateral 820W 230V	27682	1
Equipo climatización lateral 1050W 230V	27683	1
Equipo climatización lateral 1250W 230V	27684	1
Equipo climatización lateral 1600W 230V	27685	1
Equipo climatización lateral 2000W 230V	27686	1
Equipo climatización techo 410W 230V	27687	1
Equipo climatización techo 820W 230V	27688	1
Equipo climatización techo 1150W 230V	27689	1
Equipo climatización techo 1550W 230V	27690	1
Regleta iluminación armario 8W 230V con interruptor	27691	1

Otras potencias o tensiones, consultar.

Ref. 27814



*no incluye baterías



¡NOVEDAD! RACKS PARA BATERIAS SOLARES

Kit armario rack 19" para baterías solares, modelo BatRack	Ref.	U/Emb.
BatRack: armario rack 19" para baterías solares 6 U alto 310x540x500 mm (incluye: 2 bandejas)	27812	1
BatRack: armario rack19" para baterías solares 9 U alto 445x540x500 mm (incluye: 3 bandejas)	27813	1
BatRack: armario rack 19" para baterías solares 12 U alto 580x540x500 mm (incluye: 4 bandejas)	27814	1
BatRack: armario rack 19" para baterías solares 15 U alto 710x540x500 mm (incluye: 5 bandejas)	27815	1
BatRack: armario rack 19" para baterías solares 9 U alto 445x540x600 mm (incluye: 3 bandejas)	27817	1
BatRack: armario rack 19" para baterías solares 12 U alto 580x540x600 mm (incluye: 4 bandejas)	27818	1
BatRack: armario rack 19" para baterías solares 15 U alto 710x540x600 mm (incluye: 5 bandejas)	27819	1
BatRack: armario rack 19" para baterías solares 20 U alto 1155x540x600 mm (incluye: 5 bandejas)	27820	1
BatRack: armario rack 19" para baterías solares 25 U alto 1155x540x600 mm (incluye: 5 bandejas)	27821	1

Los kits incluyen el rack, 4 pies regulables y las bandejas ventiladas en función de la "U" del rack.

Ref. 2417



Ref. 2555



Ref. 2561



Ref. 2556



Ref. 2546



BANDEJAS PARA RACKS

Bandejas Extraíbles para Teclado	Ref.	U/Emb.
Bandeja extraíble 2 U para teclado (fondo 300 mm)	2417	1
Bandejas Fijas	Ref.	U/Emb.
Bandeja fija 2 U (fondo 250 mm)	2330	2
Bandeja fija 2 U (fondo 390 mm)	2344	1
Bandeja fija 1 U 4 soportes (fondo 400 mm)	2551	1
Bandeja fija 1 U 4 soportes (fondo 600 mm)	2555	1
¡Nuevo! Bandeja fija 1 U 4 soportes para BatRack (fondo 500 mm)	2561	1
¡Nuevo! Bandeja fija 1 U 4 soportes para BatRack (fondo 600 mm)	2562	1
Bandejas Regulables	Ref.	U/Emb.
Bandeja regulable 4 soportes (fondo 400 mm)	2416	1
Bandeja regulable 4 soportes (fondo de 400 a 725 mm)	2556	1
Bandeja regulable 4 soportes (fondo 800 mm)	2553	1
Bandeja regulable 4 soportes (fondo de 450 a 825 mm)	2577	1
Bandejas Regulables Extraíbles 4 Soportes	Ref.	U/Emb.
Bandeja regulable extraíble (fondo 600 mm)	2546	1
Bandeja regulable extraíble (fondo 800 mm)	2558	1

MODELOS DE RACK O SERVER RACK	REFERENCIAS COMERCIALES DE LAS BANDEJAS											
	Bandeja 10" 1U	Bandeja extraíble para teclado	Bandeja fija				Bandeja regulable				Bandeja regulable extraíble	
	24080	2417	2330	2344	2551	2555	2416	2556	2577	2553	2546	2558
■ Kit Mini Rack 10"	✓											
■ EasyPack [desmontado en Kit]		✓	✓	✓								
■ UNIRACK 400 mm		✓	✓									
■ UNIRACK 500 mm		✓	✓	✓								
■ UNIRACK 600 mm		✓	✓	✓	✓		✓	✓	✓			
■ Rack Mural IP55		✓	✓									
■ Rack Mural IP66		✓	✓									
■ Smart Rack Plus 600 mm		✓	✓	✓	✓		✓	✓				
■ Smart Rack Plus/Pack 800 mm		✓	✓	✓		✓		✓	✓		✓	
■ Smart Rack Plus/Pack 1000 mm		✓	✓	✓					✓	✓		✓
■ Net Acoustic Rack 800 mm		✓	✓	✓	✓		✓	✓				
■ PREMIUM Server Rack 1070 mm		✓	✓	✓					✓	✓		✓
■ PREMIUM Server Rack 1200 mm		✓	✓	✓					✓	✓		✓

PANELES, GUÍAS, TAPAS Y TERMOSTATO DE VENTILACIÓN PARA RACKS

Ref. 55250



Ref. 2335



Ref. 2339 Ref. 2338 Ref. 2337



Ref. 5519

Ref. 5511



Ref. 2352



Ref. 2545



Ref. 02542



Paneles Guía Cables Horizontal	Ref.	U/Emb.
Panel guía cables horizontal con 4 liras plásticas (1 U)	5520	1
Panel guía cables horizontal con 5 liras metálicas (1 U)	5526	1
Panel guía cables horizontal con tapa (1 U)	55230	1
Panel guía cables horizontal con tapa (2 U)	55240	1
Panel pasacables con cepillo (1 U)	55250	1
Panel 19" con Carril DIN	Ref.	U/Emb.
Panel con carril DIN con capacidad de 24 polos (3 U)	2335	1
Paneles Ciegos	Ref.	U/Emb.
Panel ciego 1 U 19"	2337	1
Panel ciego 2 U 19"	2338	1
Panel ciego 4 U 19"	2339	1
Guía Cables Verticales	Ref.	U/Emb.
Conjunto 10 guías cables vertical (45x65)	5519	10
Conjunto 10 guías cables vertical (70x95)	5511	10
Conjuntos de Fijación	Ref.	U/Emb.
Conjunto de fijación (tuerca, tornillo y arandela)	2352	50
Paneles de Ventilación	Ref.	U/Emb.
Ventilador 130 m³/h para rack mural	2545	1
Panel de ventilación Silent 190 m³/h para UniRack	23304	1
Panel ventilación 300 m³/h con termostato (admite hasta 2 unidades)	2542	1
Panel ventilación Silent 300 m³/h para Smart Rack Plus	23306	1
Panel ventilación 800 x 800 mm para Smart Rack Pack	02541	1
Panel de ventilación Silent 190 m³/h con termostato para UniRack	23311	1
Panel ventilación Silent 300 m³/h con termostato para Smart Rack Plus	23307	1
Panel ventilación 800 x 1000 mm para Smart Rack Pack	02542	1
Panel ventilación para armario 19" estanco IP66 (cumple la normativa IP 54)	23325	1
Panel ventilación con termostato para Highway	27634	1
Panel de ventilación redundante 76 m³ con termostato	27637	1
Panel ventilación 2 ventiladores 19", 1U, 250 m³/h con termostato digital	2544	1
Panel ventilación 4 ventiladores 19", 1U, 500 m³/h con termostato digital	2548	1

ACCESORIOS PARA RACKS

Ref. 23310



Cerradura electrónica para rack 19"	Ref.	U/Emb.
Cerradura electrónica para rack 19"	23310	1

Ref. 27650



Portaplanos autoadhesivo	Ref.	U/Emb.
Portaplanos autoadhesivo	27650	1

Ref. 5528



Liras Guía Cables	Ref.	U/Emb.
Pack 4 liras guía cables universal	5528	1



Bornes de conexión rápida QCT

Conexiones eléctricas rápidas y seguras **sin necesidad de herramientas**

- ✓ 100% libres de mantenimiento.
- ✓ Cables rígidos y flexibles.
- ✓ Fácil conexión y desconexión segura.
- ✓ Simplicidad para añadir nuevos circuitos.
- ✓ Soporta corrientes hasta 32A a 400Vca 50Hz.
- ✓ Temperatura máxima de trabajo = 80 °C.



Quick
Connection
Terminal



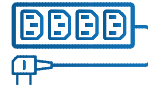

PDU Regletas Eléctricas Profesionales

PDU regletas eléctricas profesionales	76
Basic PDU "Datacenter Grade"	78
TCP/IP intelligent PDU "Datacenter Grade"	80
STS static transfer switch	82
Accesorios PDU e iPDU	82

PDU. REGLETAS DE DISTRIBUCIÓN ELÉCTRICA

Ref. 2440

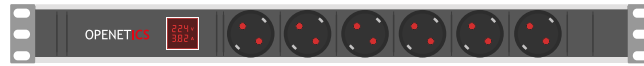

PDU Regletas Eléctricas Profesionales con Amperímetro Digital [Tomas Schuko, IEC 320 y Francesas]	Ref.	U/Emb.
PDU regleta eléctrica profesional 6 tomas schuko con amperímetro digital	2440	1
PDU regleta eléctrica profesional 6 tomas francesas con amperímetro digital	2443	1
PDU 0 U regleta eléctrica profesional 12 tomas schuko con amperímetro digital	2441	1
PDU 0 U regleta eléctrica profesional 12 tomas IEC 320 C13 con amperímetro digital	2442	1
PDU 0 U regleta eléctrica profesional 4+4 tomas schuko con 2 amperímetros digitales <i>[Bajo demanda con tomas IEC 320 C13 e IEC 320 C19]</i>	2456	1
PDU 0 U regleta eléctrica profesional 8 tomas IEC 320 C19 con amperímetro digital	26026	1

Ref. 2399



PDU Regletas Eléctricas Profesionales con Interruptor [Tomas Francesas]	Ref.	U/Emb.
PDU regleta eléctrica profesional 6 tomas francesas con interruptor	2396	1
PDU regleta eléctrica profesional 8 tomas francesas con interruptor	2399	1

Terminadas en clavijas schuko o francesas. Otras terminaciones, consultar.

Ref. 2395



PDU Regletas Eléctricas Profesionales Tomas Schuko	Ref.	U/Emb.
PDU regleta eléctrica profesional 6 tomas schuko con interruptor	2394	1
PDU regleta eléctrica profesional 8 tomas schuko con interruptor	2397	1
PDU regleta eléctrica profesional 9 tomas schuko sin interruptor	26029	1
PDU 0 U regleta eléctrica profesional 12 tomas schuko sin interruptor	2400	1
PDU regleta eléctrica profesional 6 tomas schuko con magnetotérmico	2395	1
PDU regleta eléctrica profesional 8 tomas schuko sin interruptor, clavija CETAC 32, cable 3x4	26024	1
PDU 0 U regleta eléctrica profesional 16 tomas schuko sin interruptor	26030	1
PDU 0 U regleta eléctrica profesional 24 tomas schuko sin interruptor	26031	1

Terminadas en clavijas schuko. Otras terminaciones, consultar.

PDU. REGLETAS DE DISTRIBUCIÓN ELÉCTRICA

Ref. 2377



C13

PDU Regletas Eléctricas Profesionales Tomas IEC 320 C13	Ref.	U/Emb.
PDU regleta eléctrica profesional 12 tomas IEC 320 C13 sin interruptor, clavija schuko, cable 3x2,5	2377	1
PDU regleta eléctrica profesional 19" doble circuito. Entrada 1+1 C14. Salidas 6+6 C13	26035	1
PDU regleta eléctrica profesional 12 tomas IEC 320 C13 sin interruptor, clavija CETAC 32, cable 3x4	27564	1

Terminadas en clavijas schuko. Otras terminaciones, consultar.

Ref. 26003



C13



C19

PDU Regletas Eléctricas Profesionales Tomas IEC 320 C13 / C19 *	Ref.	U/Emb.
PDU regleta eléctrica profesional 6 tomas IEC 320 C19 sin interruptor, clavija schuko, monofásica, cable 3x2,5	26000	1
PDU regleta eléctrica profesional 6 tomas IEC 320 C19 sin interruptor, clavija CETAC 16, monofásica, cable 3x2,5	26002	1
PDU regleta eléctrica profesional 6 tomas IEC 320 C19 sin interruptor, clavija CETAC 32, monofásica, cable 3x4	26003	1
PDU regleta eléctrica profesional 8 tomas IEC 320 C13 + 1 toma IEC 320 C19 sin interruptor, clavija CETAC 16A, monofásica, cable 3x2,5 mm2	27567	1
PDU regleta eléctrica profesional 8 tomas IEC 320 C13 + 1 toma IEC 320 C19 + 1 toma IEC 320 C20 sin interruptor, clavija CETAC 32, monofásica, cable 3x2,5	26010	1
PDU regleta eléctrica profesional 6 tomas IEC 320 C19 sin interruptor, clavija CETAC 32, trifásica, cable 5x4 (2 tomas sobre cada fase)	26004	1

** Varias opciones de cable y clavijas (schuko, CETAC, etc.).*

Ref. 27716



C13

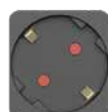

Schuko

PDU Doble Alimentación	Ref.	U/Emb.
PDU 19" doble alimentación 6+6 C13	27716	1
PDU 0 U doble alimentación 6+6 schuko	26072	1
PDU 0 U doble alimentación 12+12 C13	26071	1
PDU 0 U doble alimentación 8+8 schuko	26073	1

BASIC PDU “DATACENTER GRADE”





PDU profesionales , 0U , Datacenter Grade, con tomas IEC 60320 C13 y C19. Cable de 2,5 m terminado en clavija IEC 60309 Cetac C16/C32. Modelos con y sin protecciones magnetotérmicas. Posibilidad de incorporar voltímetro y amperímetro. Otras configuraciones son posibles según especificaciones del cliente.



BASIC PDU “Datacenter Grade”	Ref.	U/Emb.
BASIC PDU 0 U, 18 tomas IEC 320 C13 + 2 tomas IEC 320 C19	26009	1
BASIC PDU 0 U, 24 tomas IEC 320 C13	26011	1
BASIC PDU 0 U, 12 tomas IEC 320 C13 + 6 tomas IEC 320 C19	26015	1
BASIC PDU 0 U, 24 tomas IEC 320 C13 + 4 tomas IEC 320 C19	26013	1
BASIC PDU 0 U, 12 tomas IEC 320 C19, trifásica 22 Kw	26018	1
BASIC PDU 0 U, 12 tomas IEC 320 C13 + 1 interruptor automático 10A + 6 tomas IEC 320 C19 + 1 interruptor automático 16A	26016	1
BASIC PDU 0 U, 12 tomas IEC 320 C19	26017	1
BASIC PDU 0 U, 24 tomas IEC 320 C13 + 2 interruptores automáticos 10A	26012	1
BASIC PDU 0 U, 24 tomas IEC 320 C13 + 1 interruptor automático 10A + 4 tomas IEC 320 C19 + 1 interruptor automático 16A	26014	1
BASIC PDU 0 U, 16 tomas IEC 320 C13 + 1 interruptor automático 16A + 4 tomas IEC 320 C19 + 1 interruptor automático 16A	2445	1
BASIC PDU 0 U, 36 tomas IEC 320 C13 + 6 tomas IEC 320 C19, monofásica C32	26027	1
BASIC PDU 0 U, 36 tomas IEC 320 C13 + 6 tomas IEC 320 C19, monofásica C32, con protección térmica	2446	1
BASIC PDU 0 U, 36 tomas IEC 320 C13 + 6 tomas IEC 320 C19, trifásica C32	26028	1
BASIC PDU 0 U, 12 tomas IEC 320 C19 + 3 interruptores automáticos 16A, trifásica 22 Kw	26019	1
BASIC PDU 0 U, 36 tomas IEC 320 C13 + 6 tomas IEC 320 C19, trifásica C32, con protección térmica	2447	1

Terminados en clavija CETAC IEC 60309 de 32A. Otras terminaciones, consultar.

Referencias de BASIC PDU "Datacenter Grade" según tipo de toma

Ref.	BASIC PDU "Datacenter Grade"			
	 Tomas C13	 Tomas C19	 Interruptor Automático 10A	 Interruptor Automático 16A
26009	18	2	-	-
26011	24	-	-	-
26015	12	6	-	-
26013	24	4	-	-
26018	-	12	-	-
26016	12	6	1	1
26017	-	12	-	-
26012	24	-	2	-
26014	24	4	1	1
2445	16	4	-	2
26027	36	6	-	-
2446	36	6	-	-
26028	36	6	-	-
26019	-	12	-	3
2447	36	6	-	-

BASIC SMART TCP/IP PDU (DATACENTER GRADE)



Basic Smart TCP/IP PDU (Datacenter Grade)	Ref.	U/Emb.
BASIC Smart TCP/IP PDU 0 U, 18 tomas IEC 320 C13 + 2 tomas IEC 320 C19, IP	26009/IP	1
BASIC Smart TCP/IP PDU 0 U, 24 tomas IEC 320 C13, IP	26011/IP	1
BASIC Smart TCP/IP PDU 0 U, 12 tomas IEC 320 C13 + 6 tomas IEC 320 C19	26015/IP	1
BASIC Smart TCP/IP PDU 0 U, 24 tomas IEC 320 C13 + 4 tomas IEC 320 C19, IP	26013/IP	1
BASIC Smart TCP/IP PDU 0 U, 12 tomas IEC 320 C19, trifásica 22 K, IP	26018/IP	1
BASIC Smart TCP/IP PDU 0 U, 12 tomas IEC 320 C13 + 1 interruptor automático 10A + 6 tomas IEC 320 C19 + 1 interruptor automático 16A, IP	26016/IP	1
BASIC Smart TCP/IP PDU 0 U, 12 tomas IEC 320 C19, IP	26017/IP	1
BASIC Smart TCP/IP PDU 0 U, 24 tomas IEC 320 C13 + 2 interruptores automáticos 10A, IP	26012/IP	1
BASIC Smart TCP/IP PDU 0 U, 24 tomas IEC 320 C13 + 1 interruptor automático 10A + 4 tomas IEC 320 C19 + 1 interruptor automático 16A, IP	26014/IP	1
BASIC Smart TCP/IP PDU 0 U, 16 tomas IEC 320 C13 + 1 interruptor automático 16A + 4 tomas IEC 320 C19 + 1 interruptor automático 16A, IP	2445/IP	1
BASIC Smart TCP/IP PDU 0 U, 36 tomas IEC 320 C13 + 6 tomas IEC 320 C19, monofásica C32, IP	26027/IP	1
BASIC Smart TCP/IP PDU 0 U, 36 tomas IEC 320 C13 + 6 tomas IEC 320 C19, monofásica C32, con protección térmica, IP	2446/IP	1
BASIC Smart TCP/IP PDU 0 U, 36 tomas IEC 320 C13 + 6 tomas IEC 320 C19, trifásica C32, IP	26028/IP	1
BASIC Smart TCP/IP PDU 0 U, 12 tomas IEC 320 C19 + 3 interruptores automáticos 16A, trifásica 22 Kw, IP	26019/IP	1
BASIC Smart TCP/IP PDU 0 U, 36 tomas IEC 320 C13 + 6 tomas IEC 320 C19, trifásica C32, con protección térmica, IP	2447/IP	1

PDU

TCP/IP INTELLIGENT PDU “DATACENTER GRADE”

PDU gestionables IP, display LCD para corriente y tensión, con medición remota de corriente, alarmas, y posibilidad de conexión de sensores. Tomas IEC 60320 tipos C13, C19 y schuko. Clavija Cetac C32, 230 V.

Metered, software “A”

Medición de tensión y corriente total PDU

METERED, SOFTWARE “A”	Ref.	U/Emb.
TCP/IP INTELLIGENT PDU 19”, 1U, 8 tomas IEC 320 C13, clavija CETAC 16, 230V	26046	1
TCP/IP INTELLIGENT PDU, 0 U, 20 tomas schuko + 4 tomas IEC 320 C19, clavija CETAC 32, 230V	26038	1
TCP/IP INTELLIGENT PDU, 0 U, 24 tomas IEC 320 C13, clavija CETAC 32, 230V	26040	1
TCP/IP INTELLIGENT PDU, 0 U, 20 tomas IEC 320 C13 + 4 tomas IEC 320 C19, clavija CETAC 32, 230V	26041	1

Individually metered, software “B”

Medición de tensión y corriente individual de cada toma.

INDIVIDUALLY METERED, SOFTWARE “B”	Ref.	U/Emb.
TCP/IP INTELLIGENT PDU 19”, 1U, 8 tomas IEC 320 C13, clavija CETAC 16, 230V	26047	1
TCP/IP INTELLIGENT PDU, 0 U, 20 tomas schuko + 4 tomas IEC 320 C19, clavija CETAC 32, 230V	26039	1
TCP/IP INTELLIGENT PDU, 0 U, 24 tomas IEC 320 C13, clavija CETAC 32, 230V	26042	1
TCP/IP INTELLIGENT PDU, 0 U, 20 tomas IEC 320 C13 + 4 tomas IEC 320 C19, clavija CETAC 32, 230V	26043	1

Switched, software “D”

Medición individual de tensión y corriente, control ON/OFF y secuencial en cada toma.

SWITCHED, SOFTWARE “D”	Ref.	U/Emb.
TCP/IP INTELLIGENT PDU 19”, 1U, 8 tomas IEC 320 C13, clavija CETAC 16, 230V	26048	1
TCP/IP INTELLIGENT PDU, 0 U, 20 tomas schuko + 4 tomas IEC 320 C19, clavija CETAC 32, 230V	26037	1
TCP/IP INTELLIGENT PDU, 0 U, 24 tomas IEC 320 C13, clavija CETAC 32, 230V	26044	1
TCP/IP INTELLIGENT PDU, 0 U, 20 tomas IEC 320 C13 + 4 tomas IEC 320 C19, clavija CETAC 32, 230V	26045	1



STS STATIC TRANSFER SWITCH

Ref. 26055



STS Static Transfer Switch	Ref.	U/Emb.
Static Transfer Switch STS 16A	26054	1
Static Transfer Switch STS 32A	26057	1
Static Transfer Switch STS 16A gestionable IP	26055	1
Static Transfer Switch STS 32A gestionable IP	26058	1

Ref. 26065



Accesorios para STS Static Transfer Switch	Ref.	U/Emb.
Módulo de gestión IP para STS	26065	1
Set 2 cables IEC 320 C19 a clavija schuko	26060	1

ACCESORIOS PARA INTELLIGENT PDU

Conectables sobre las PDU, facilitan alarmas cuando se producen variaciones fuera de los umbrales programados.

Ref. 26052



Accesorios para Intelligent PDU	Ref.	U/Emb.
Sensor de temperatura y humedad	26050	1
Sensor de puerta	26053	1
Sensor de humos	26051	1
Sensor de agua	26052	1
Sensor box	26076	1

ACCESORIOS PARA PDU

Ref. S038 Ref. S037



Ref. 26082



Accesorios para PDU	Ref.	U/Emb.
Clavija hembra IEC 60320 C13	S038	1
Clavija macho IEC 60320 C14	S037	1
Clavija hembra IEC 60320 C19	S031	1
Clavija macho IEC 60320 C20	S036	1
Cable schuko a C13 de 1,8 m	26084	1
Cable schuko a C19 de 1,8 m	26085	1
Cable C13 a C14 de 1,8 m	26080	1
Cable C13 a C20 de 1,8 m	26081	1
Cable C14 a C19 de 1,8 m	26082	1
Cable C19 a C20 de 1,8 m	26083	1

 **RACK PPAL. COM**
RPC1

 Ubicación
Planta -1 ▾

 Puntos de red
120

 Long. media (m)
40

 Cajas terminales

 Configurar rack

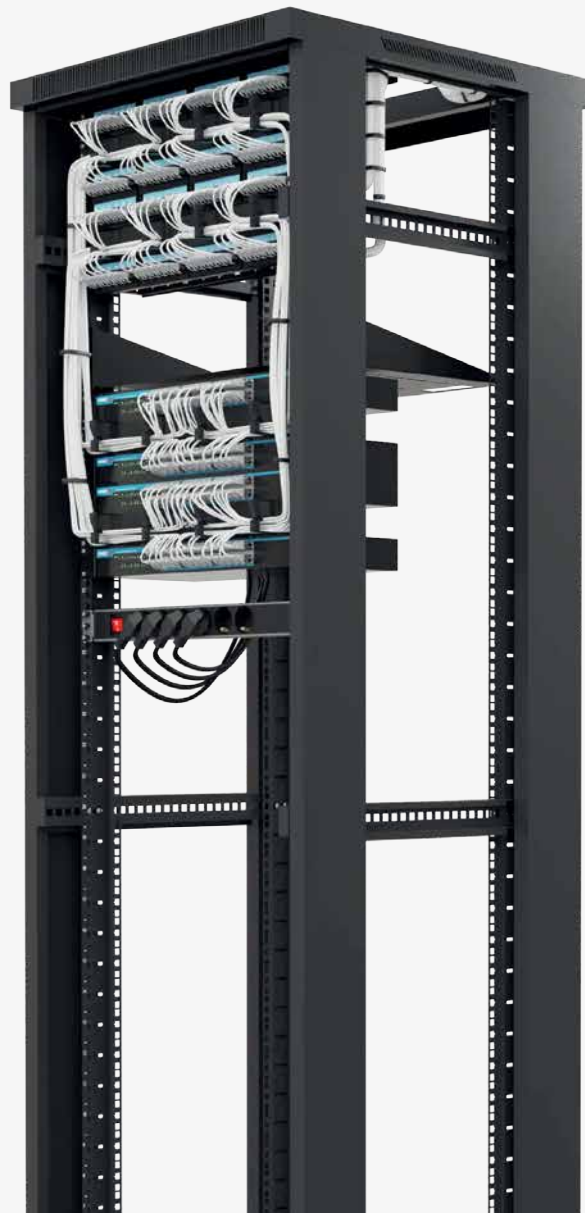

Flexibilidad y configuración a medida

Define el número de puntos de red y obtén tu solución VDI al instante



Solución global



Optimiza tu tiempo



Profesionalízate



Crece y gana



mynet.openetics.com

OPENETICS

Fabricamos soluciones VOZ & DATOS

El 1º configurador VDI del mundo para diseñar redes LAN empresariales y Campus

Diseñado para Ingenierías

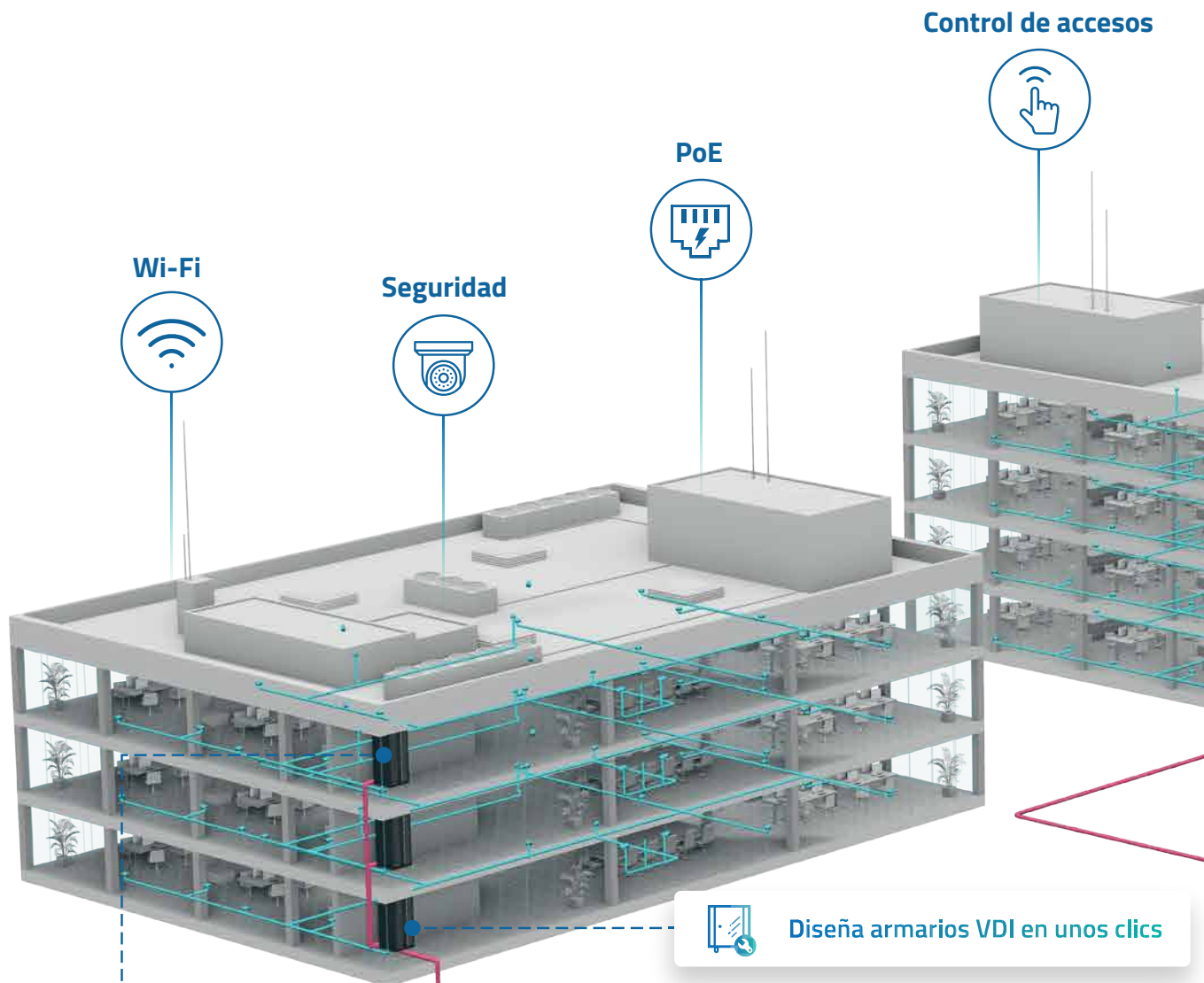

 Descarga diagramas y racks 19" en CAD

 Diseña armarios VDI en unos clics

 Obtén presupuesto

myNET
mynet.openetics.com



Iluminación PoE



HVAC



Transmisión 4K y 8K



Cloud



VoIP

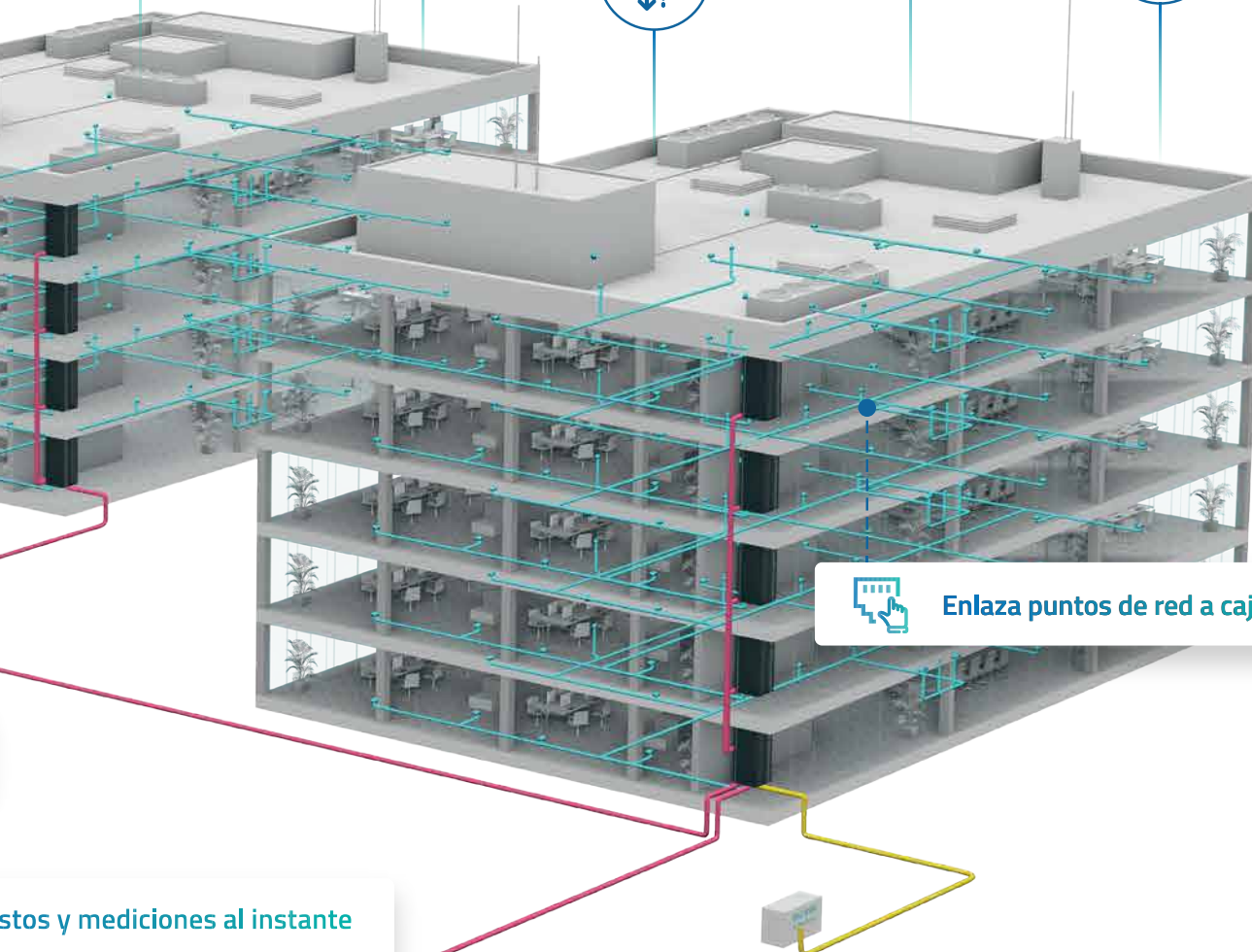

Enlaza puntos de red a cajas VDI

Costos y mediciones al instante



Configura el cableado troncal



Fabricante especialista en soluciones de VOZ y DATOS

Cableado Estructurado de Cobre | Fibra Óptica | Electrónica de Red | Racks 19" | PDUs

SEDE CENTRAL Y FÁBRICA EN ESPAÑA

Barcelona





Ctra. de Rubí 324. Nave D.
Polígono Industrial Can Guitard
08228. Terrassa, Barcelona.

CONTACTO

 www.openetics.com

 info@openetics.com

 937 848 212

Copyright ©2023 OPENETICS International S.L. Todos los derechos reservados. Las especificaciones aquí publicadas están actualizadas en la fecha de edición de este documento salvo errores tipográficos o informáticos. Puesto que mejoramos continuamente nuestros productos, OPENETICS se reserva el derecho de modificar las especificaciones sin que medie notificación previa. Las imágenes mostradas son orientativas y no necesariamente son una reproducción fiel del producto real.

REFERENCIA BIBLIOGRÁFICA: GUÍA DE PRODUCTO N°23 / ESP [ED. ABRIL 2023]

OPENETICS
Connecting Quality™